

AGGIOLIGHT - ÔFJOSŠĚĚĚĚ
Composition B0

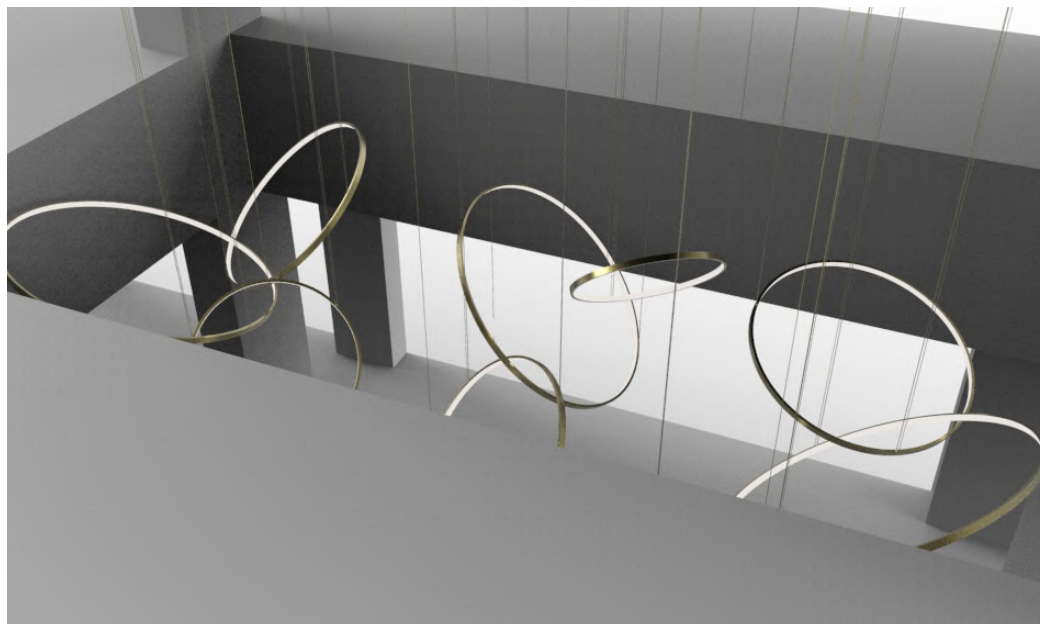

Ø1500mm: 3 IN - Ø1200mm: 3 IN - Ø900mm: 3 IN

AGGIOLIGHT - ÔFJOSŁĖĆĬ
 Composition B0

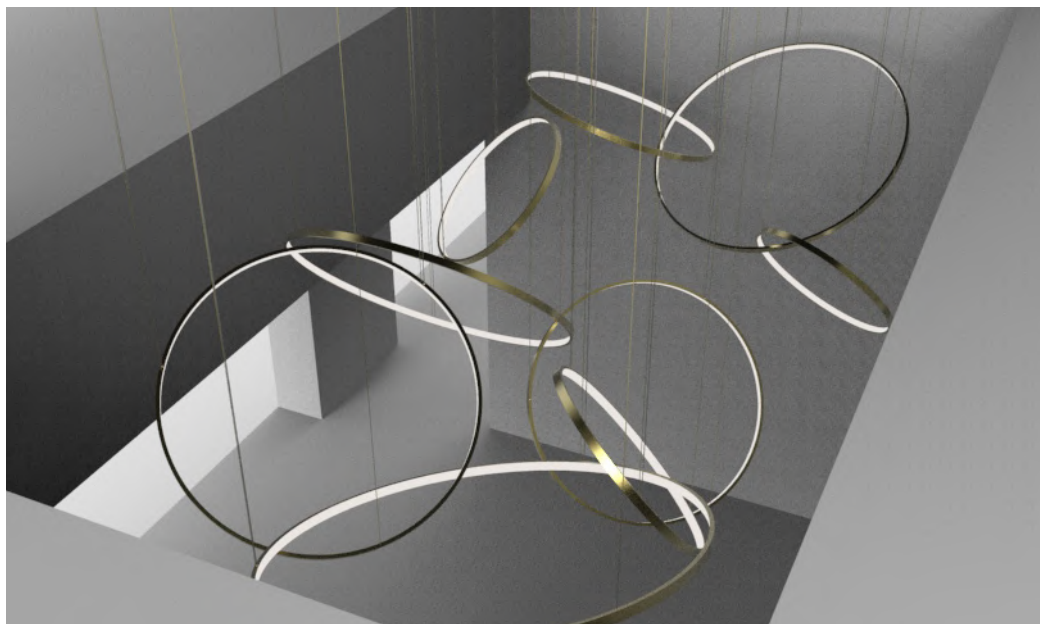
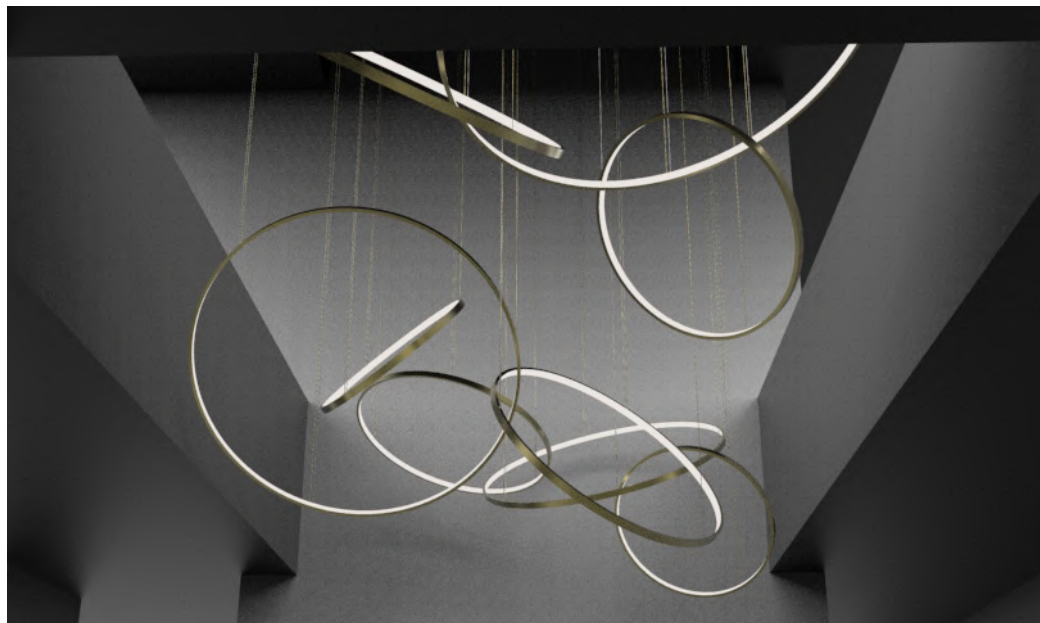
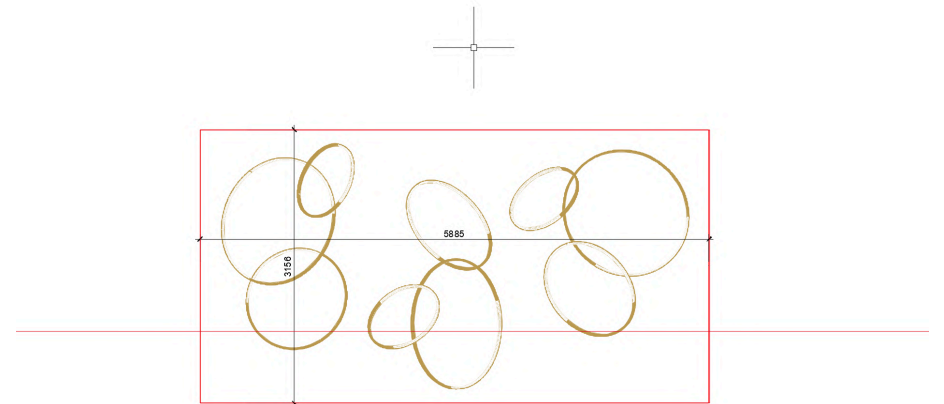
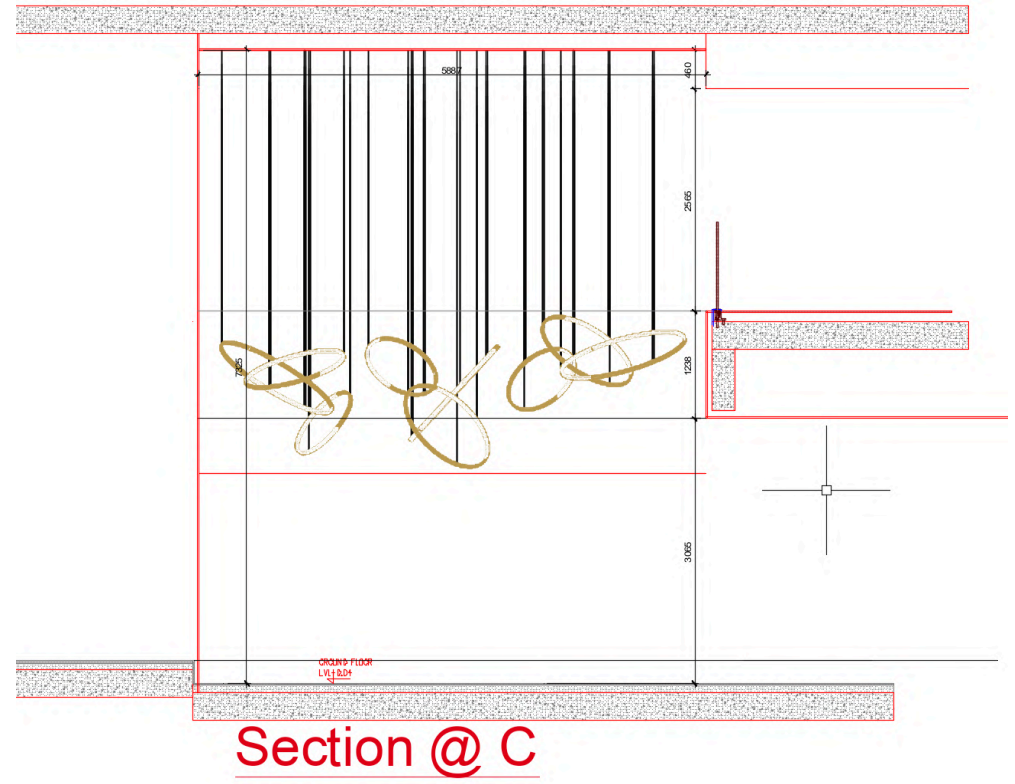
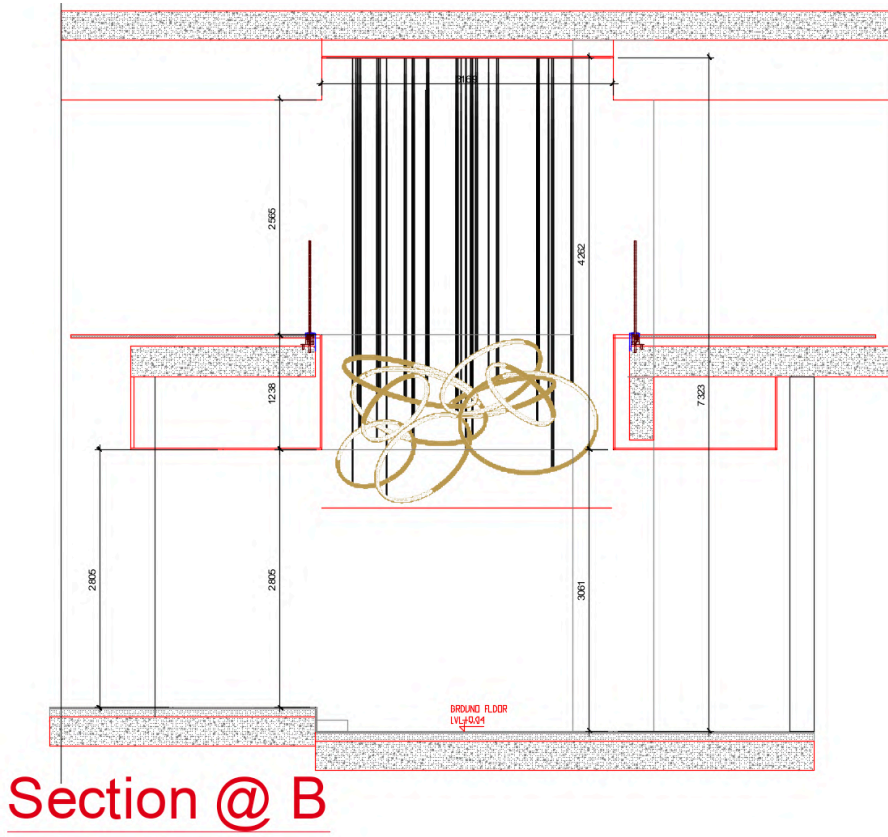

AGGIOLIGHT - ÔFJ0ŠĚĉĉĭ
Composition C0

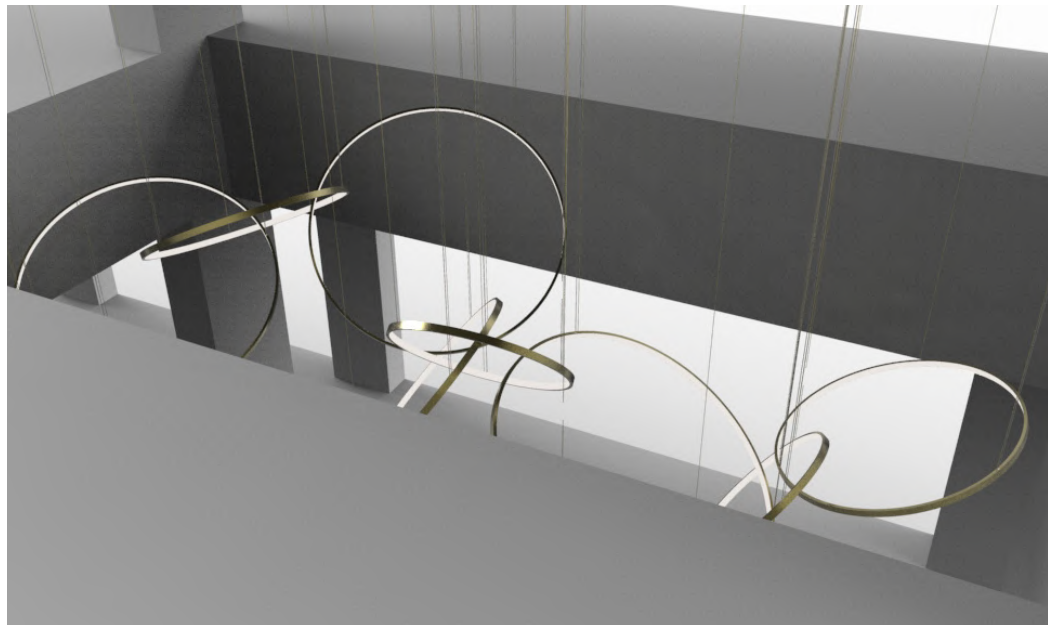
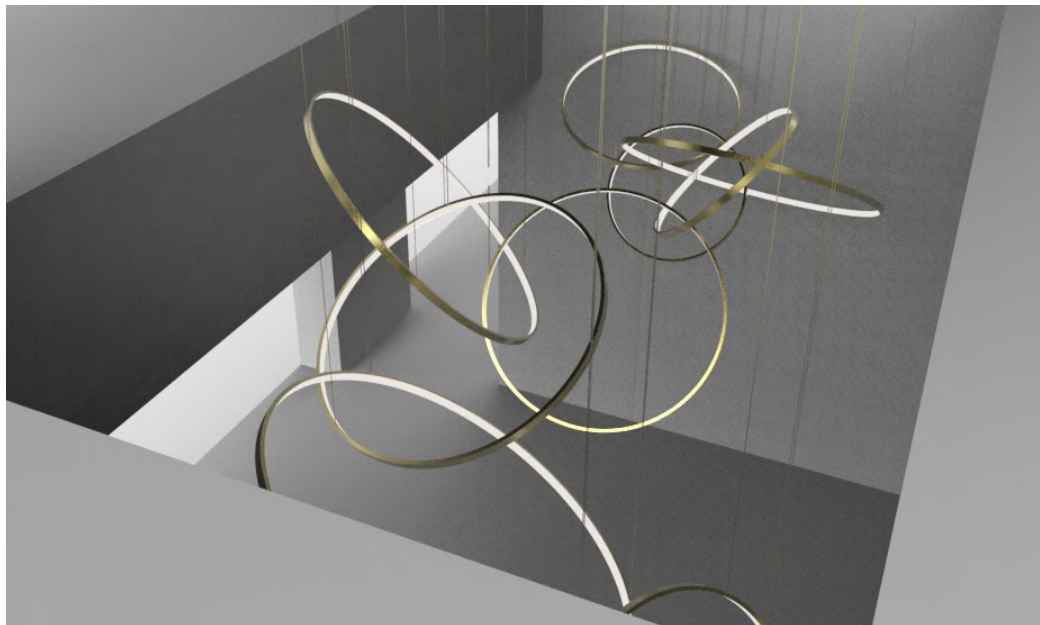
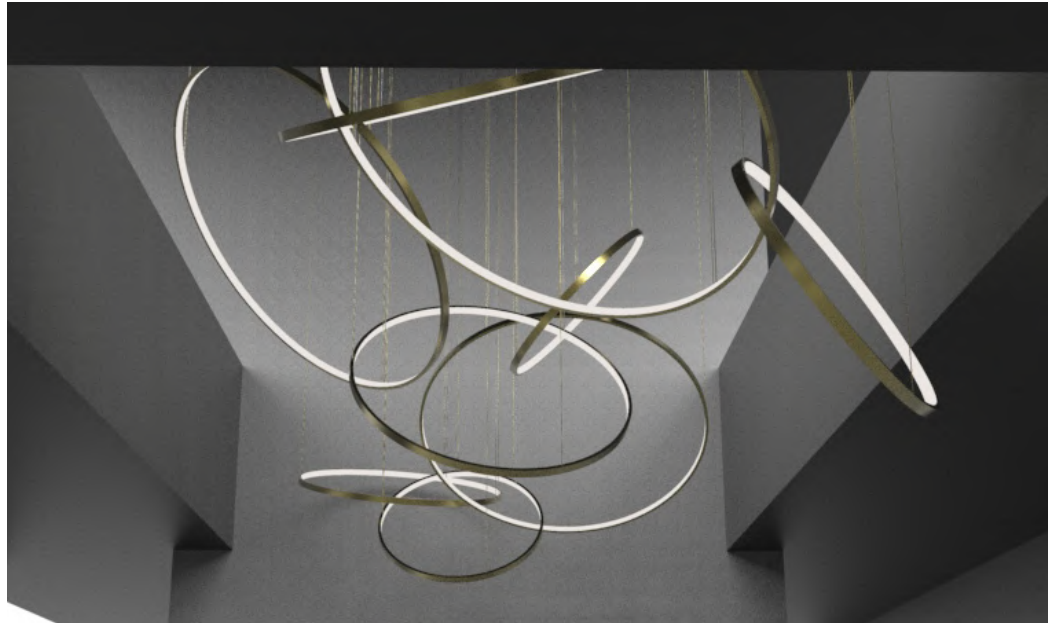
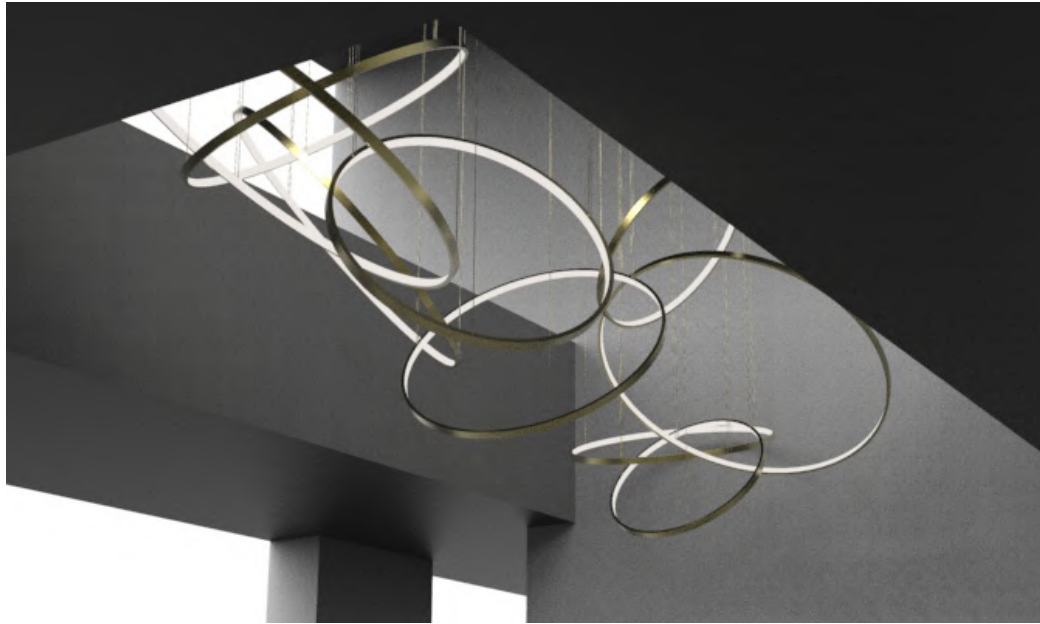

Ø1500mm: 3 IN - Ø1200mm: 3 IN - Ø900mm: 3 IN

AGGIOLIGHT - ÔFJOS
Composition C0

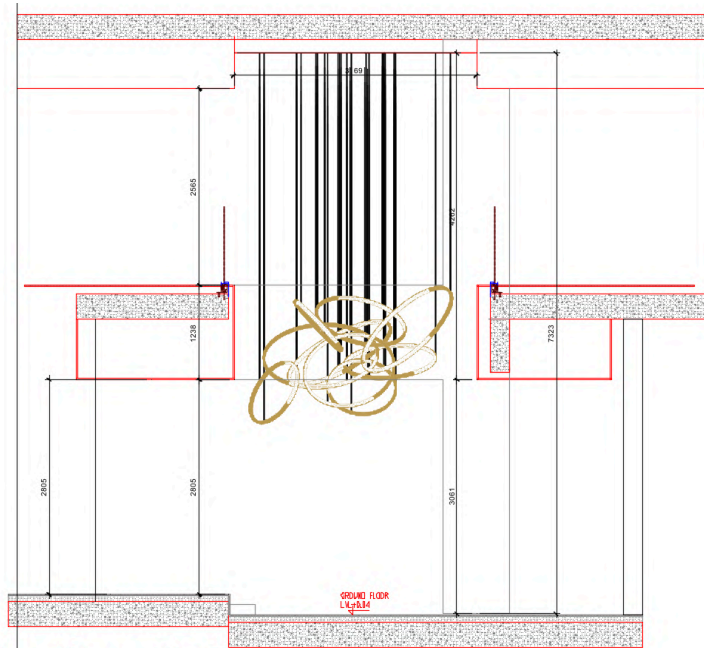

Section @ B

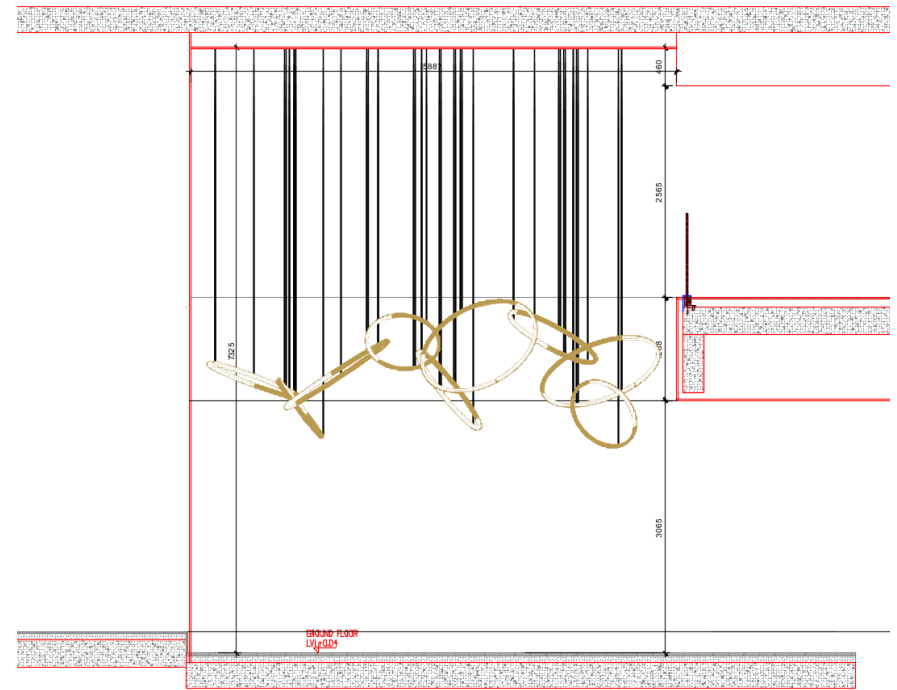

Section @ C

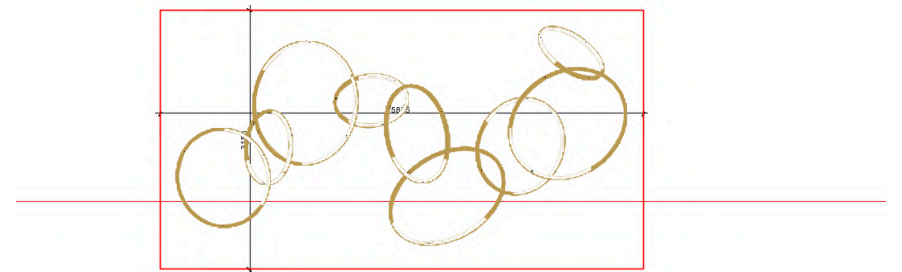
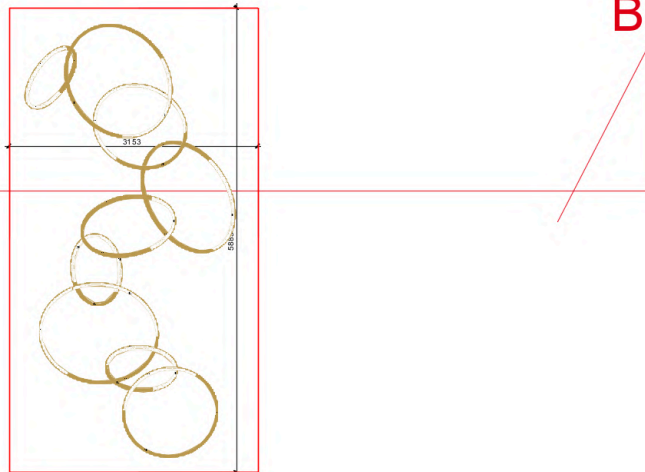

AGGIOLIGHT - ÔFJ0ŠĚĚĚĚĚ
Composition C1

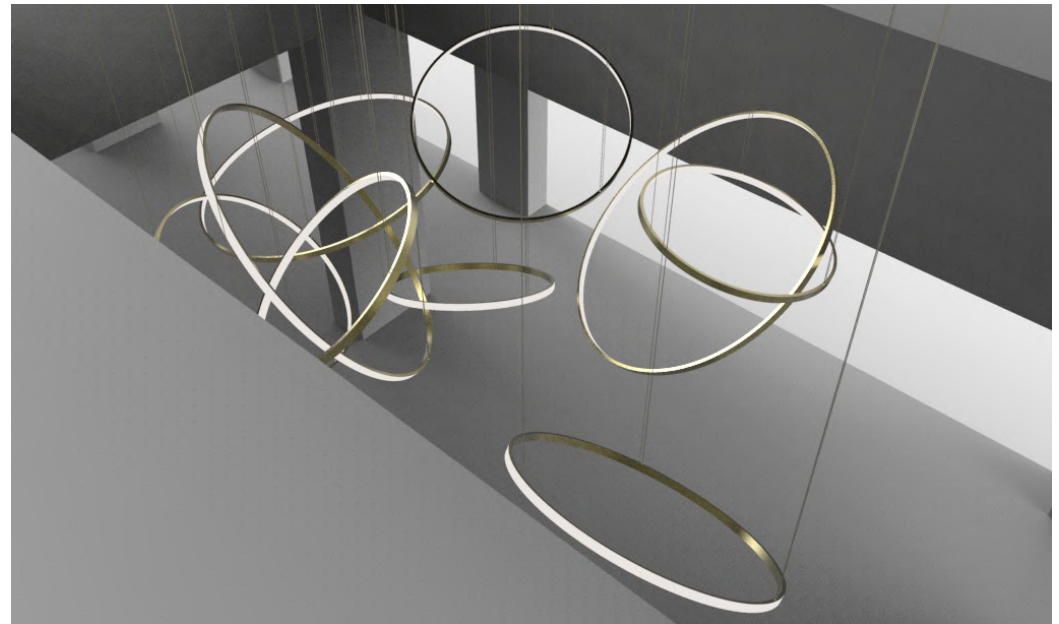
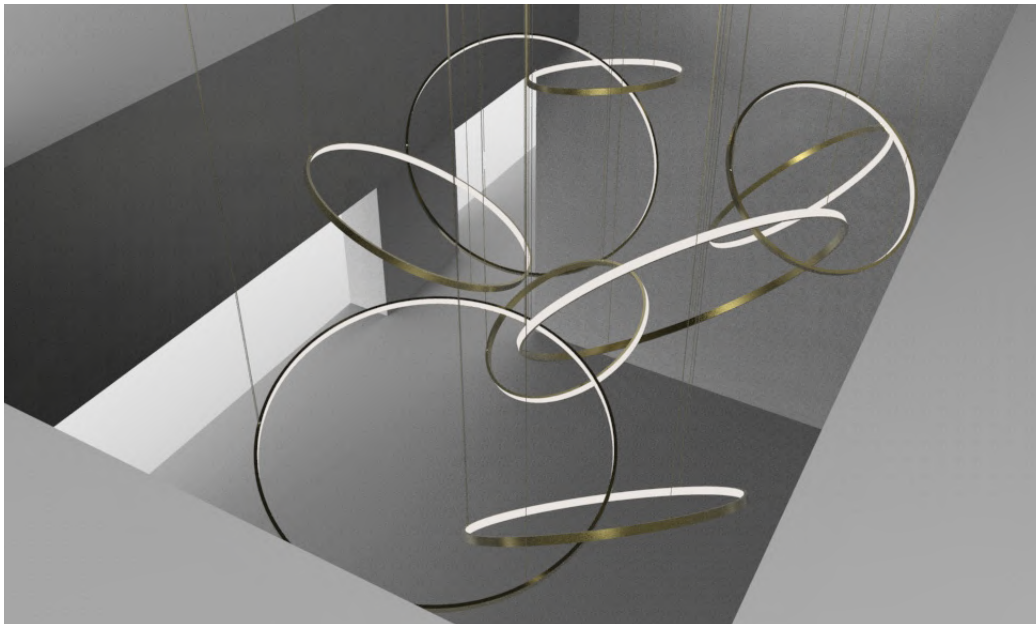
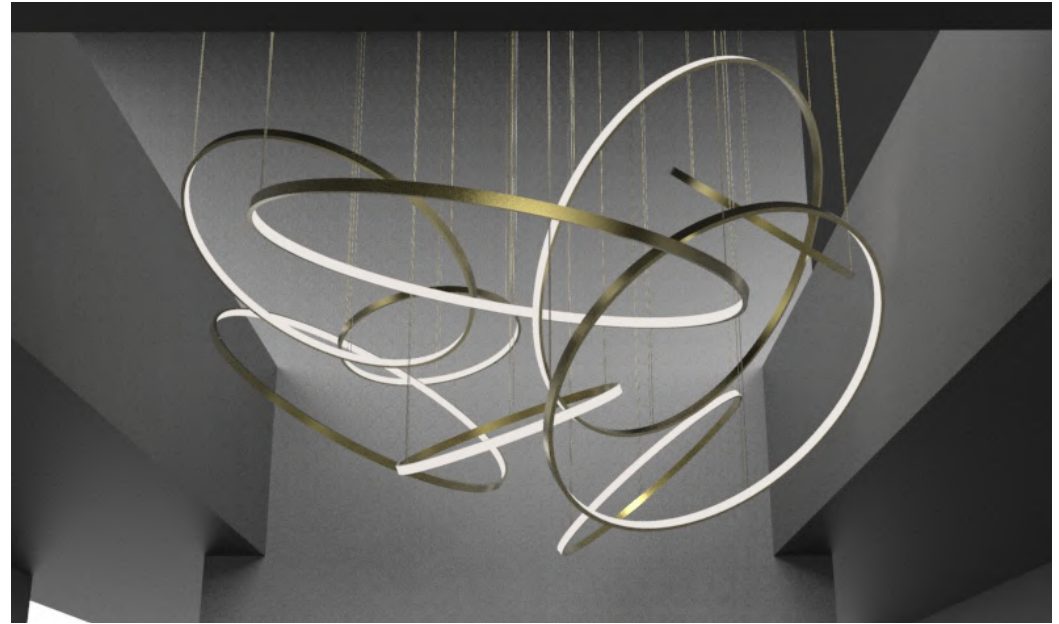
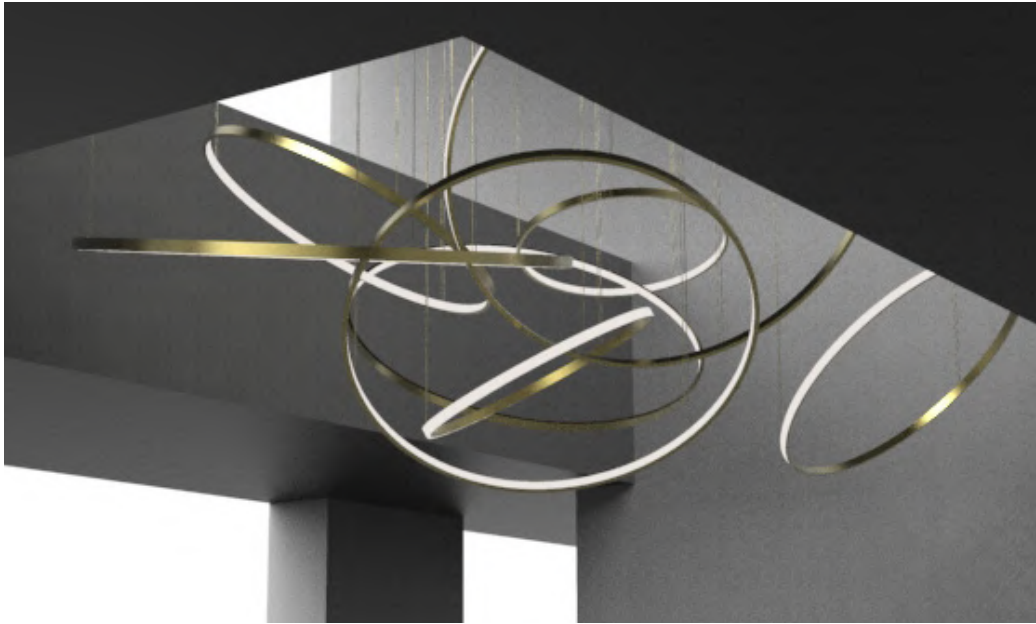

Ø1500mm: 2 IN / 1 OUT - Ø1200mm: 2 IN / 1 OUT - Ø900mm: 2 IN / 1 OUT

AGGIOLIGHT - ÔFJOS
Composition C1

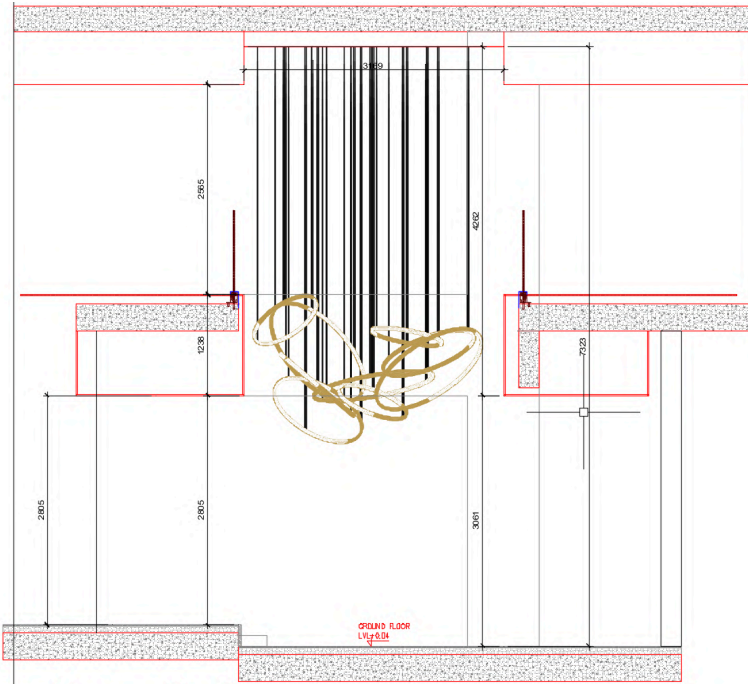

Section @ B

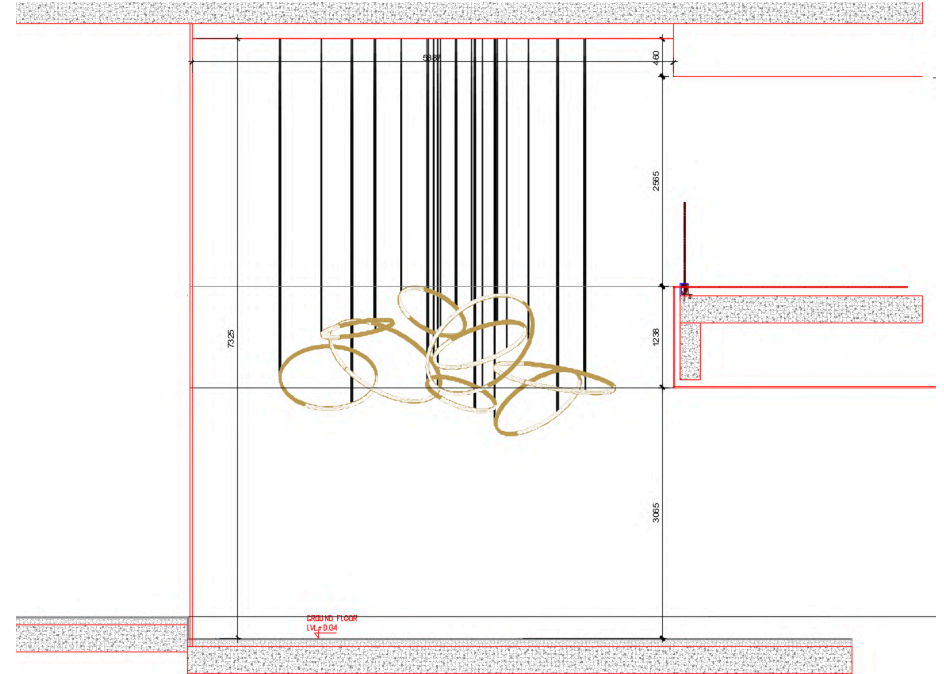

Section @ C

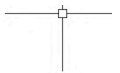
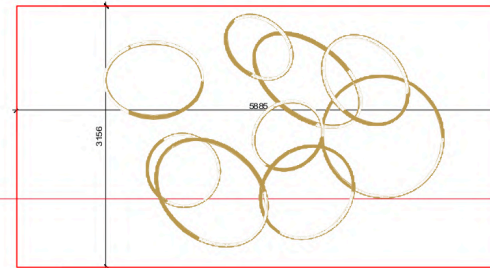
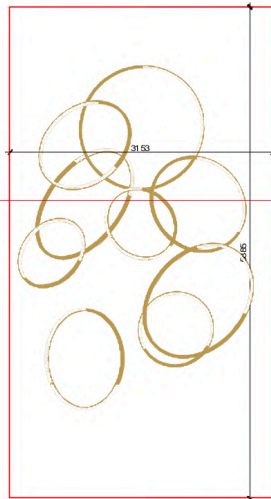

AGGIOLIGHT - ÓFJÓŠÉÉĪ
Composition C2

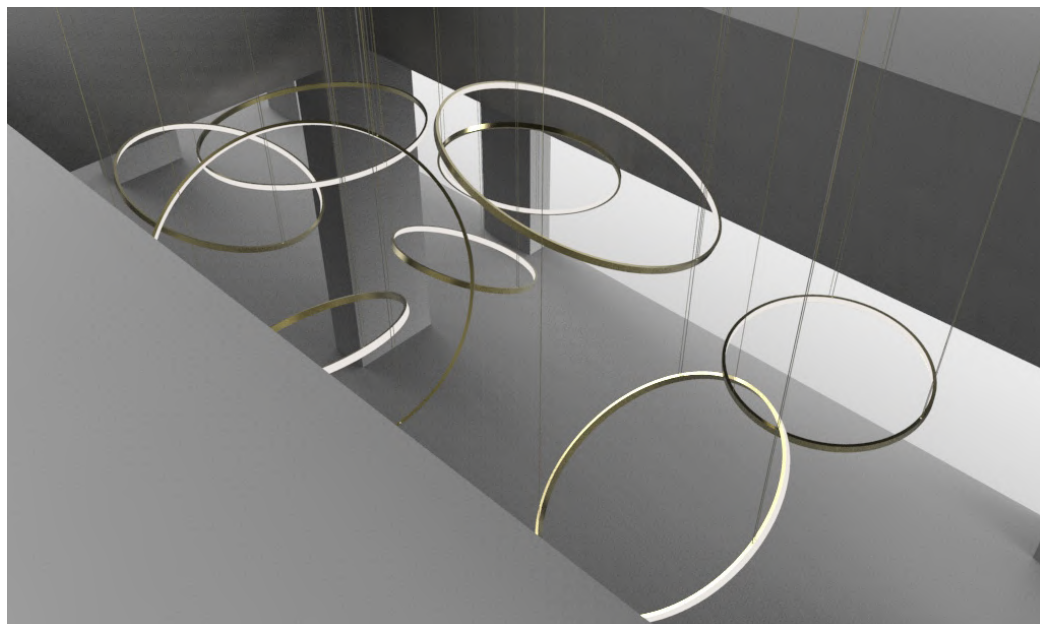
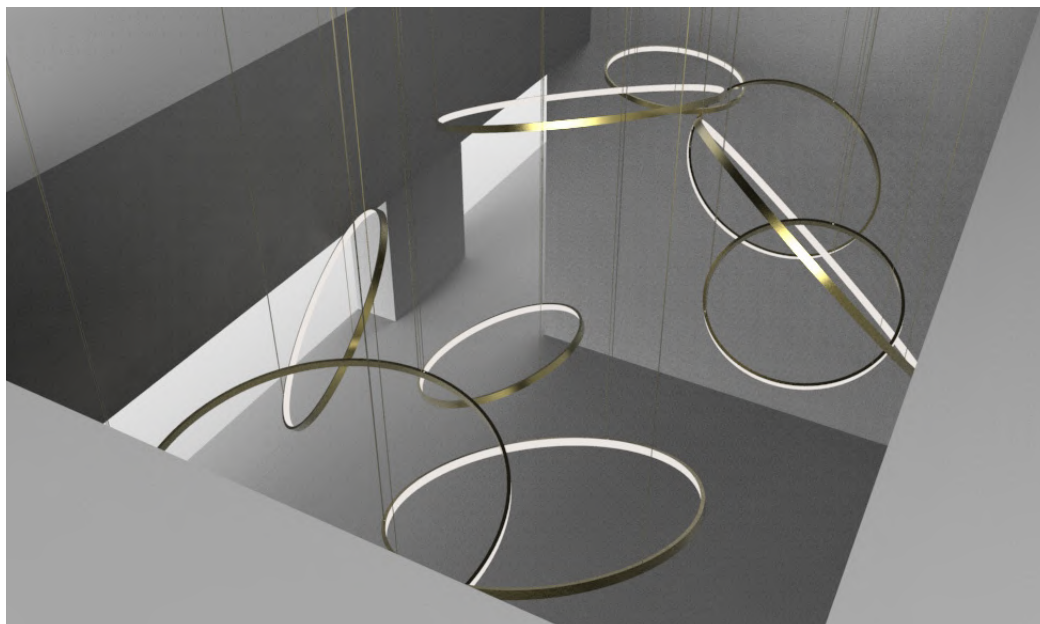

Ø1500mm: 2 IN / 1 OUT - Ø1200mm: 2 IN / 1 OUT - Ø900mm: 2 IN / 1 OUT

AGGIOLIGHT - C19AL-0007
Composition C2

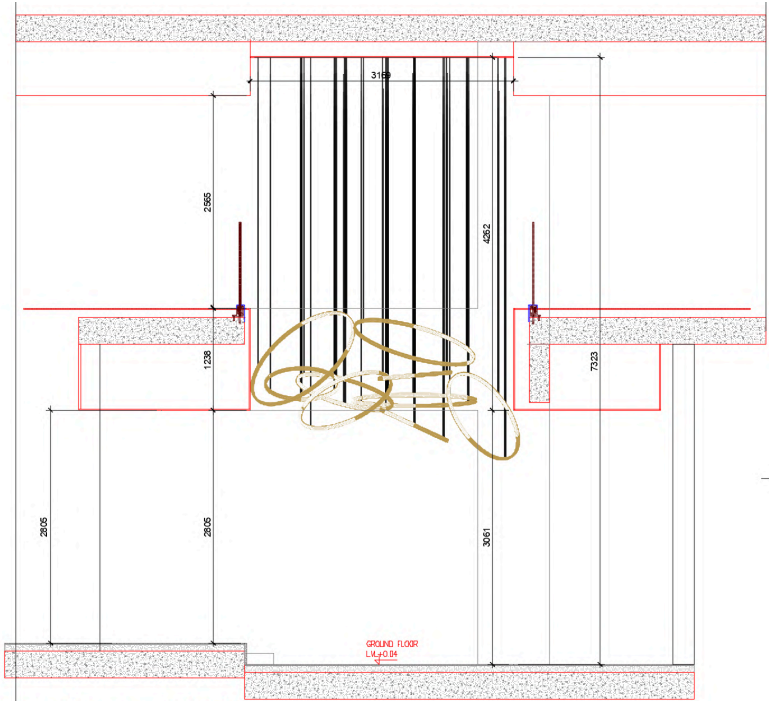

Section @ B

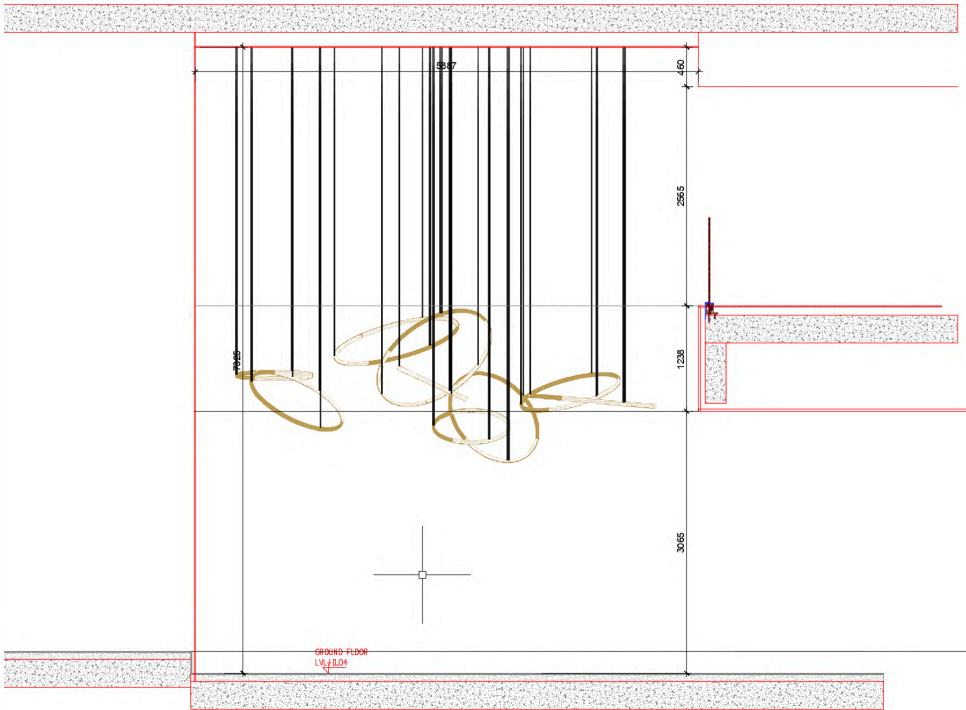

Section @ C

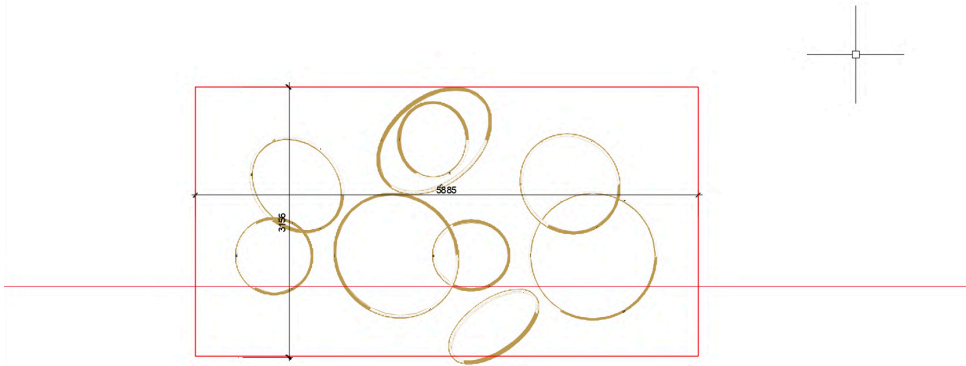
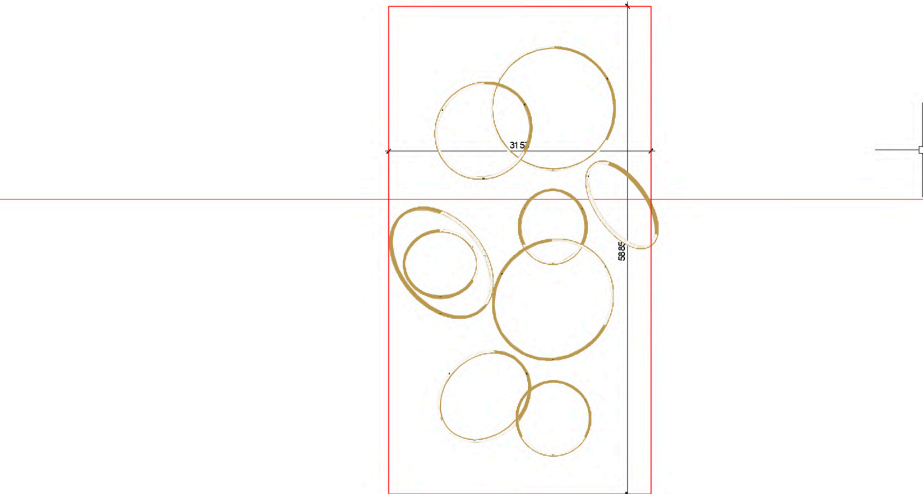

AGGIOLIGHT - C19AL-0007
Composition C3

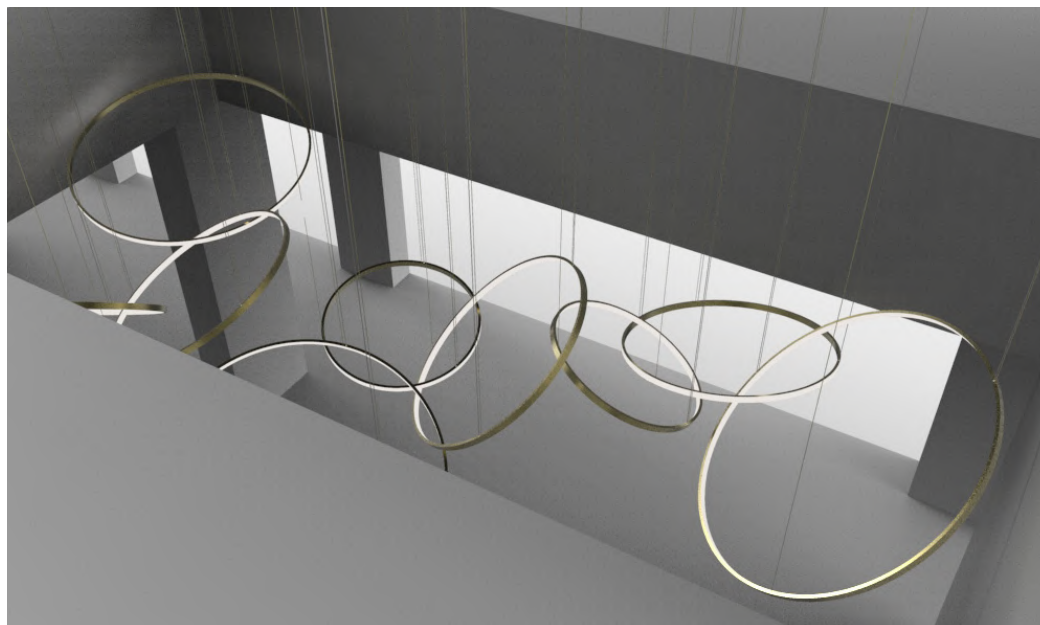
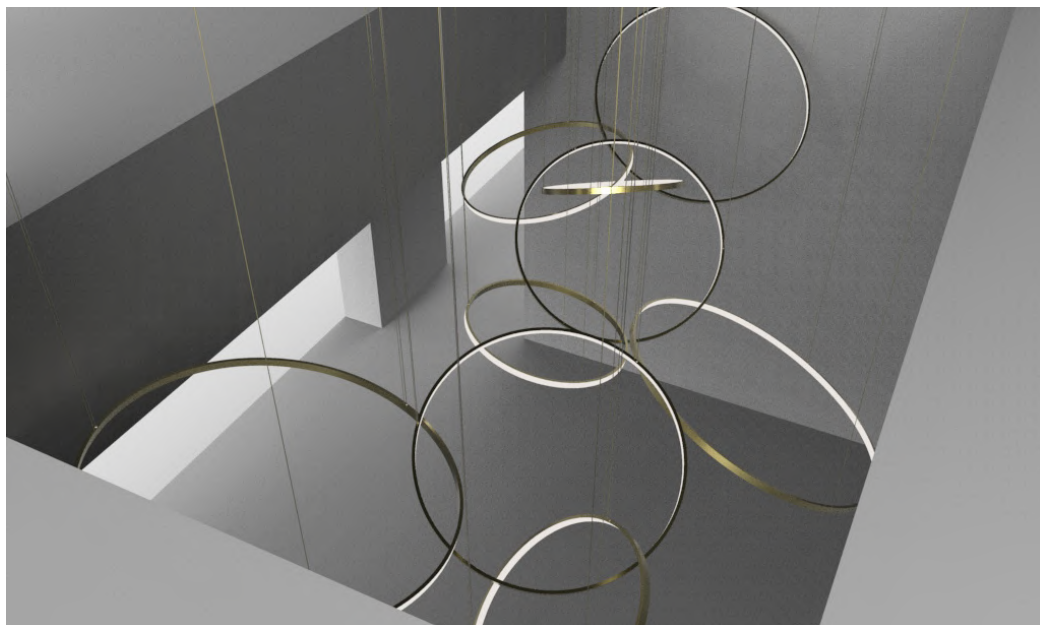
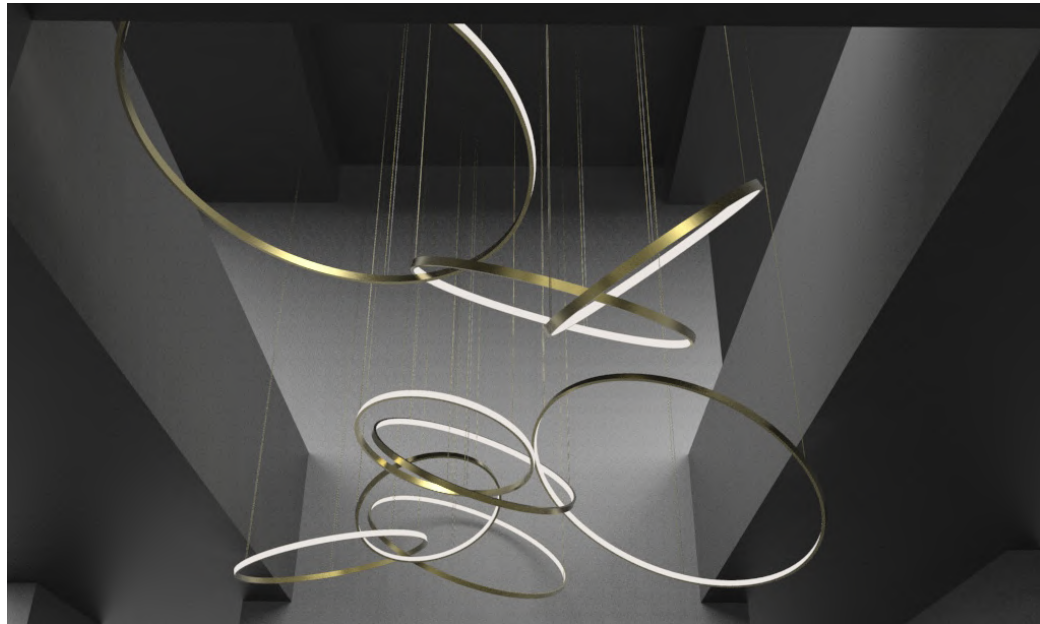
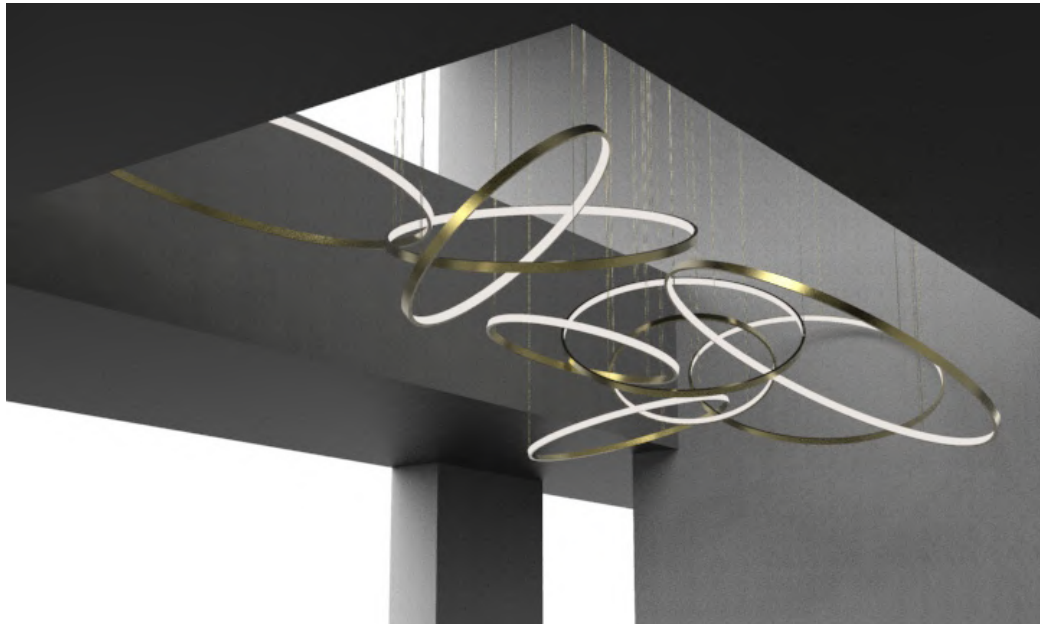

Ø1500mm: 2 IN / 1 OUT - Ø1200mm: 2 IN / 1 OUT - Ø900mm: 2 IN / 1 OUT

AGGIOLIGHT - C19AL-0007

Composition C3

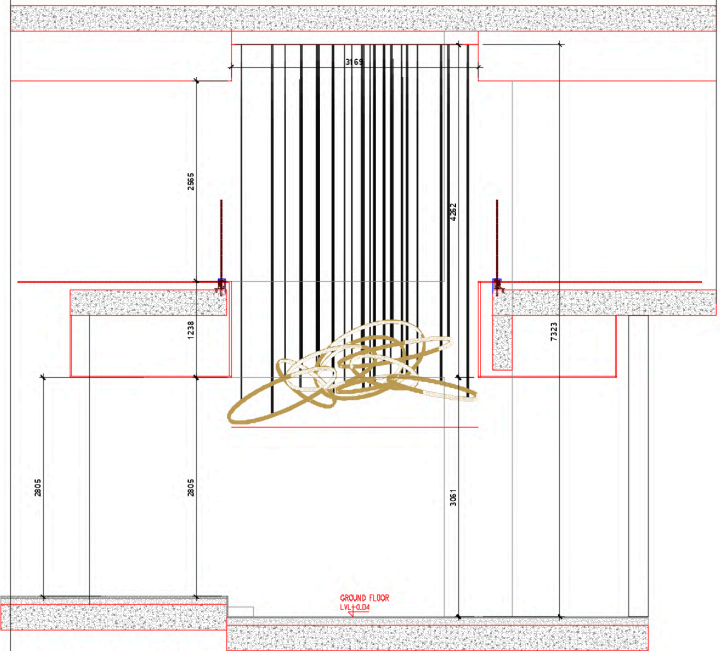

Section @ B

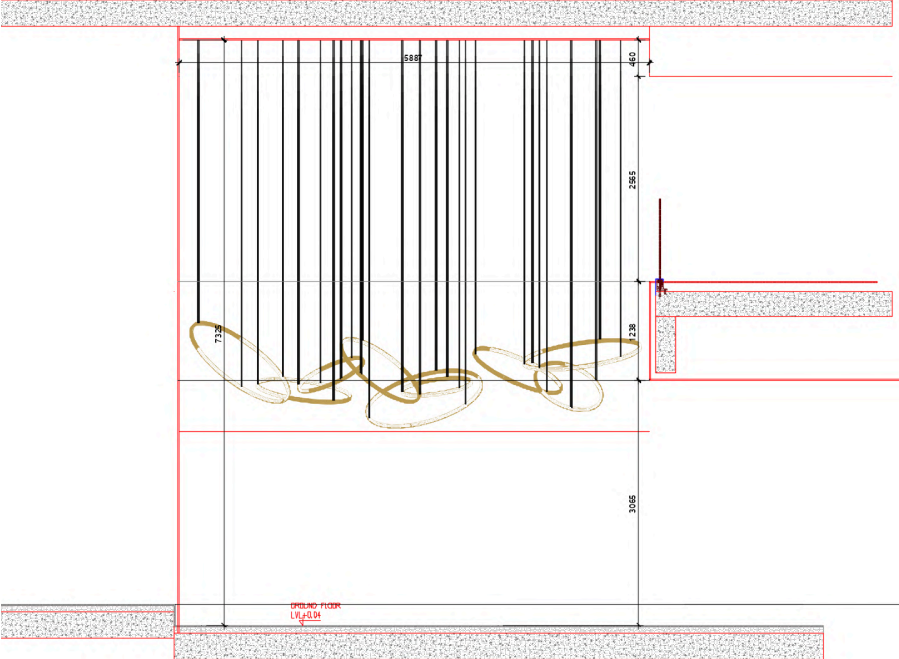

Section @ C

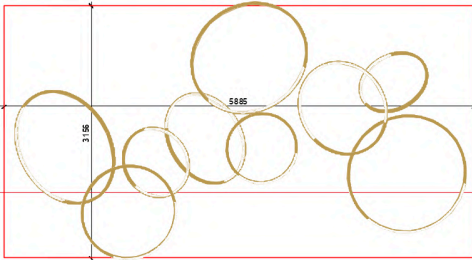
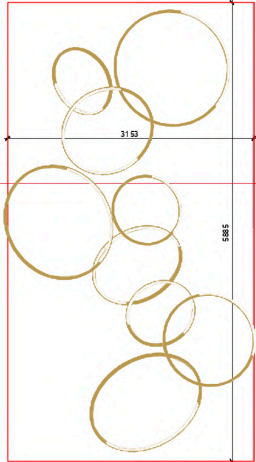

AGGIOLIGHT - C19AL-0007
Composition C4

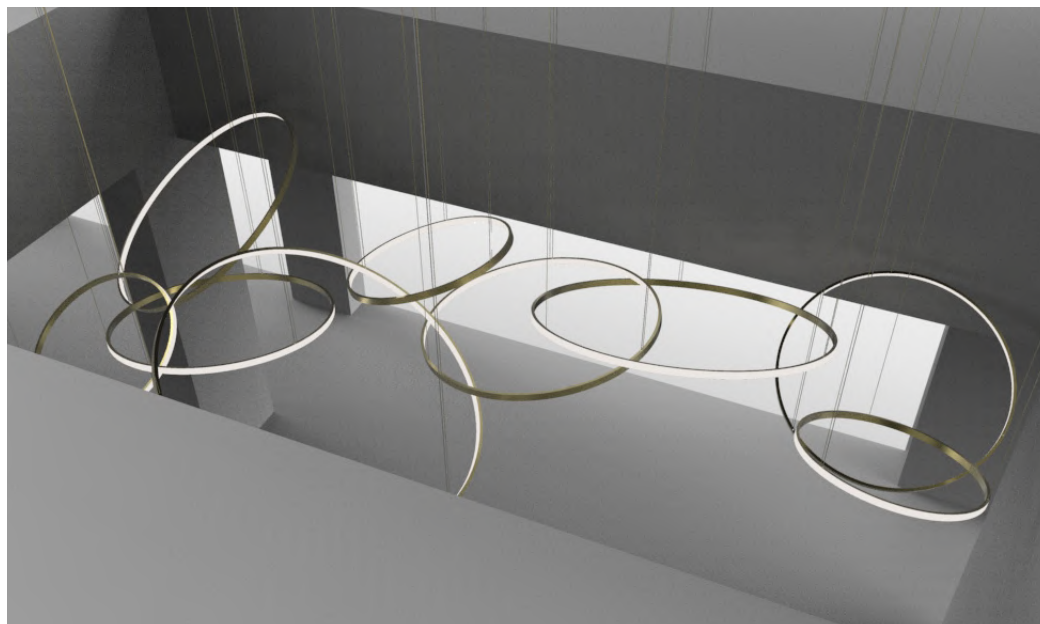
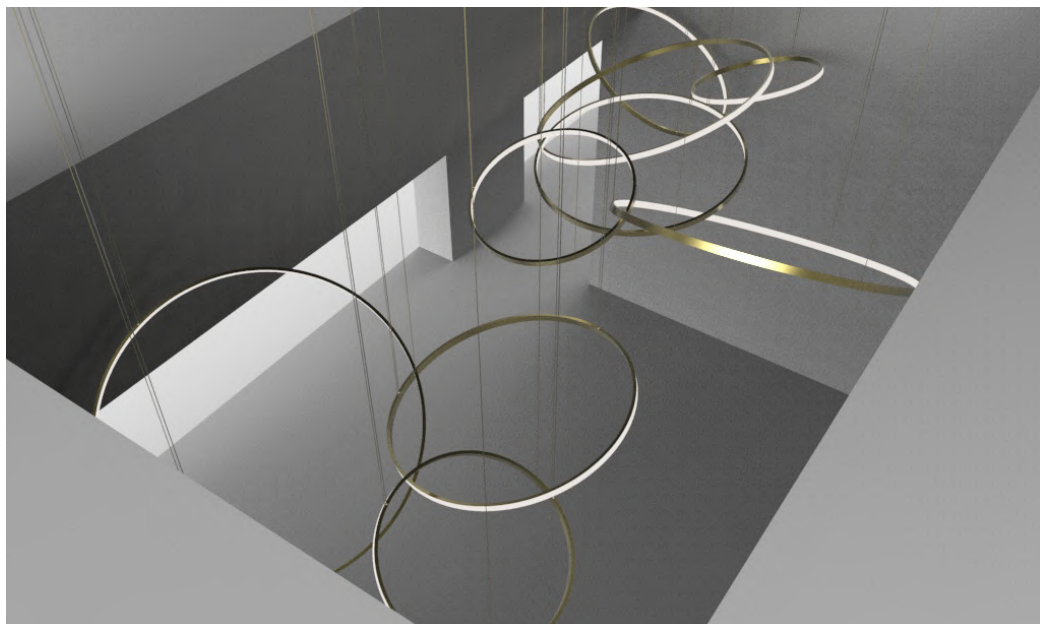
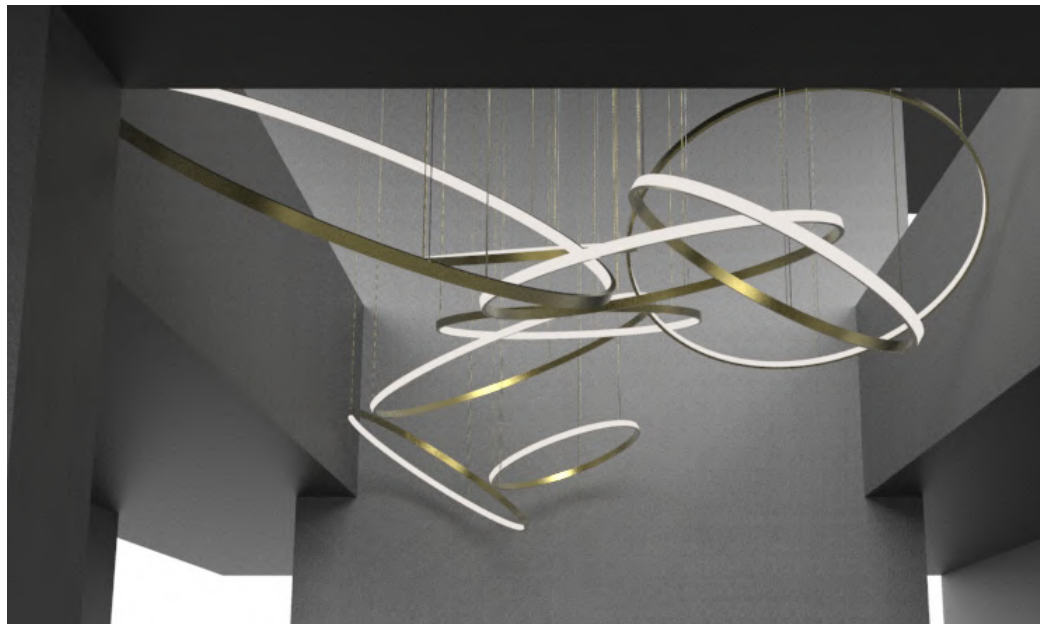
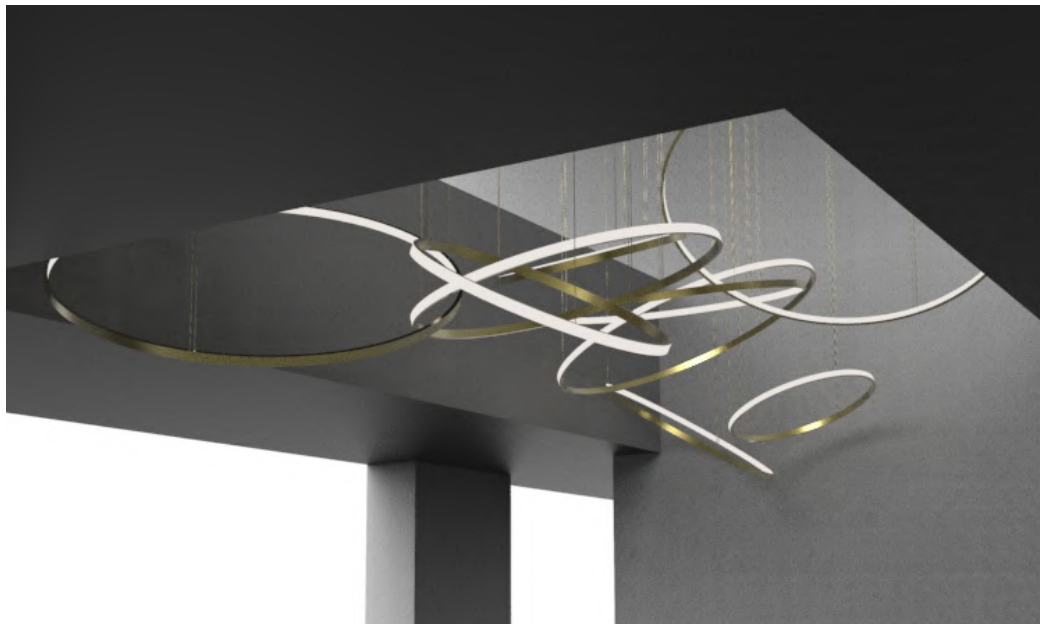

Ø1500mm: 2 IN / 1 OUT - Ø1200mm: 2 IN / 1 OUT - Ø900mm: 1 IN / 2 OUT

AGGIOLIGHT - C19AL-0007

Composition C4

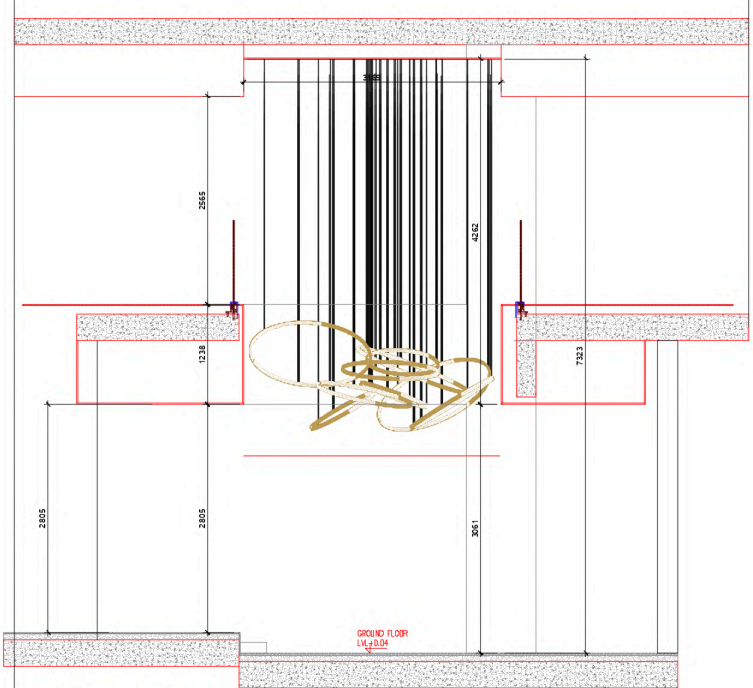

Section @ B

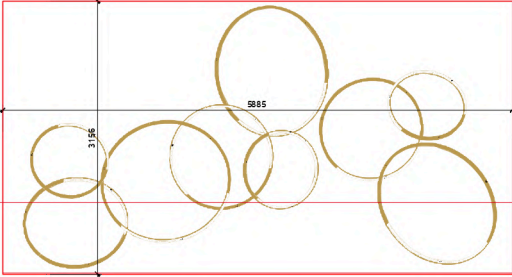
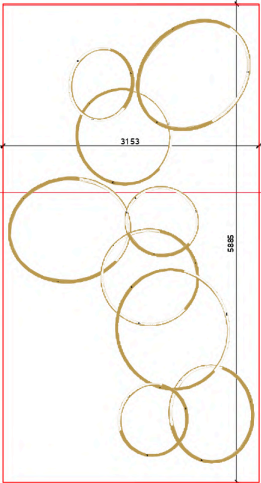
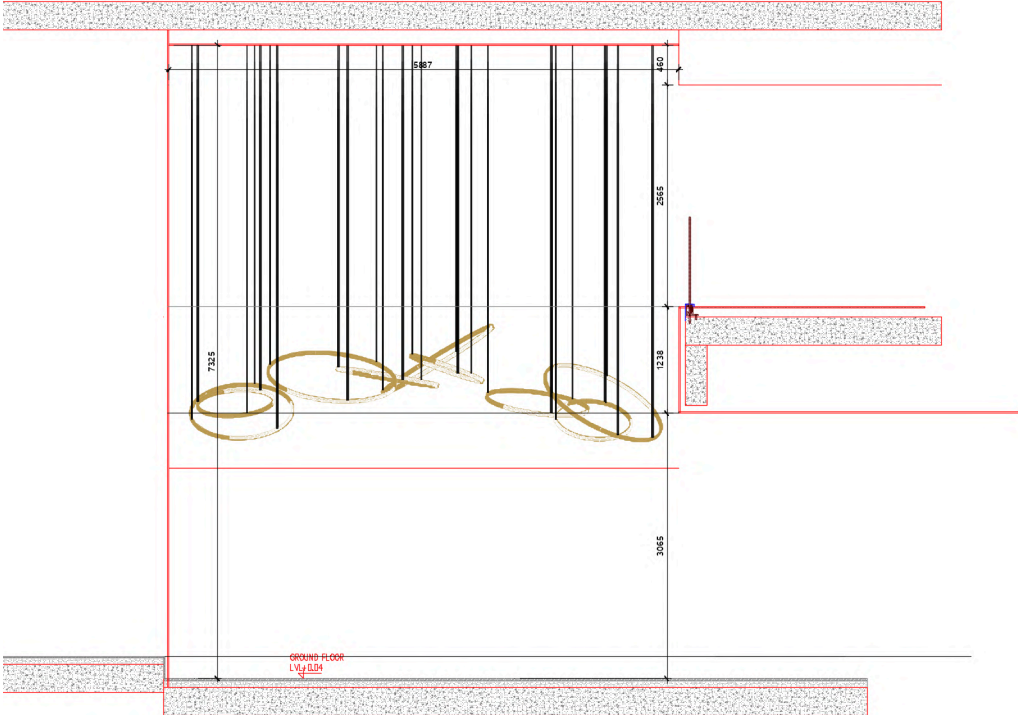

AGGIOLIGHT - C19AL-0007
Composition C5

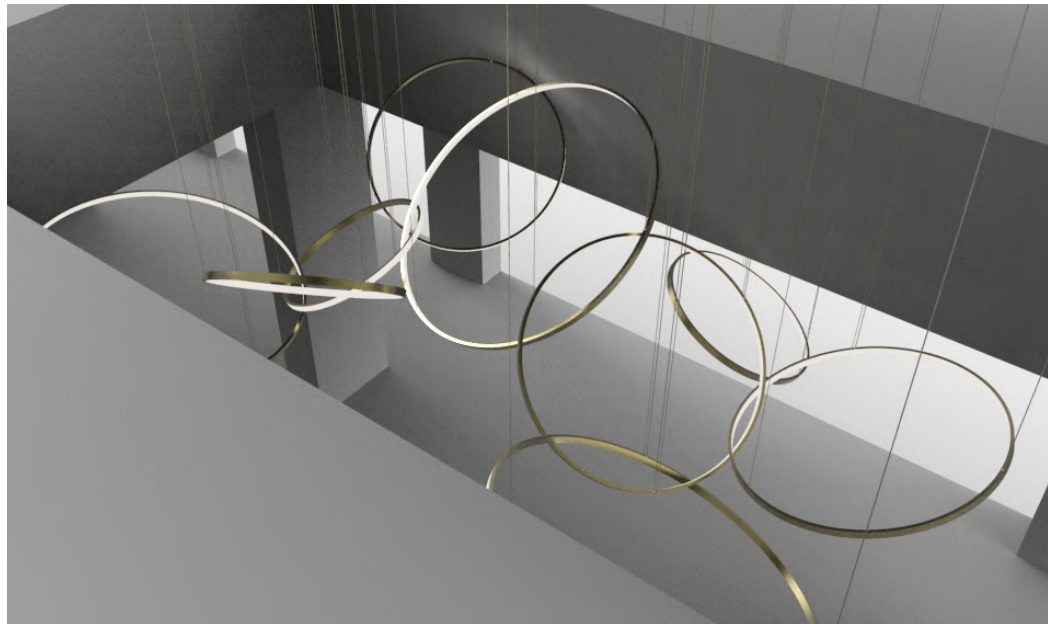
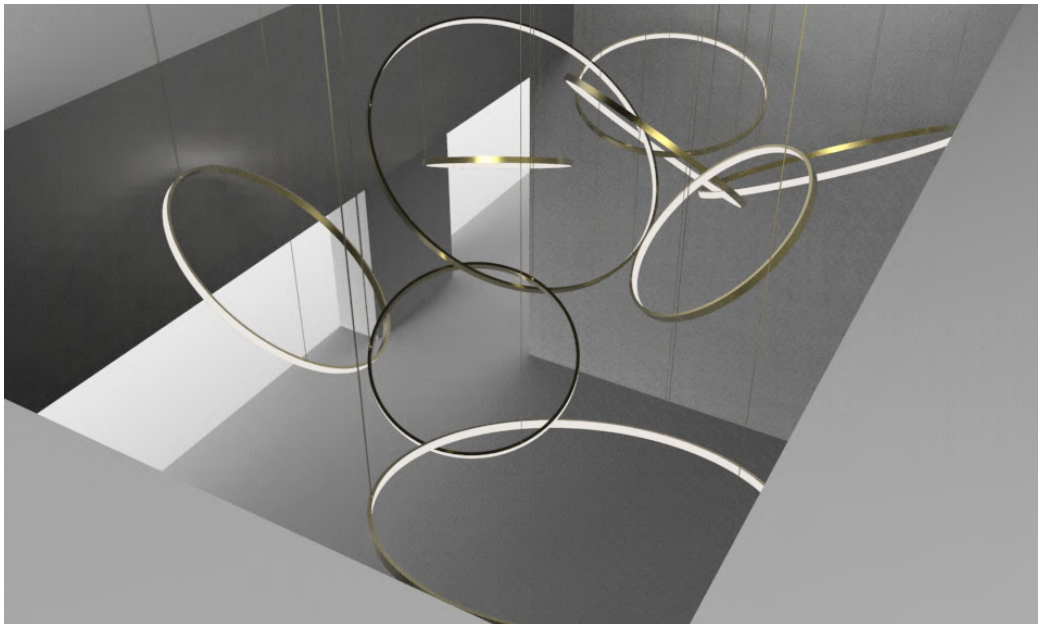
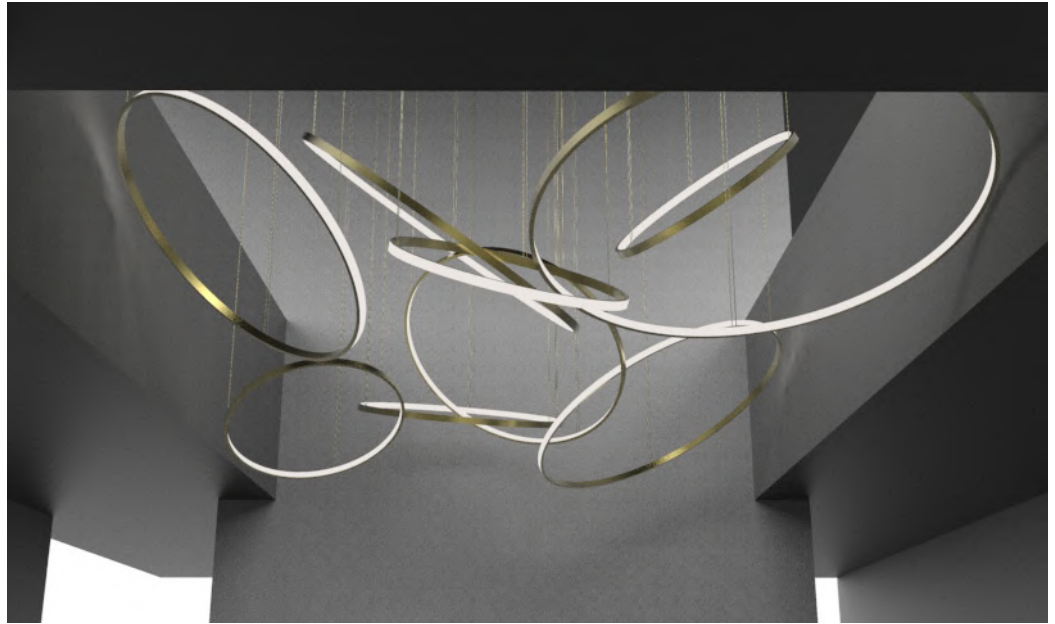
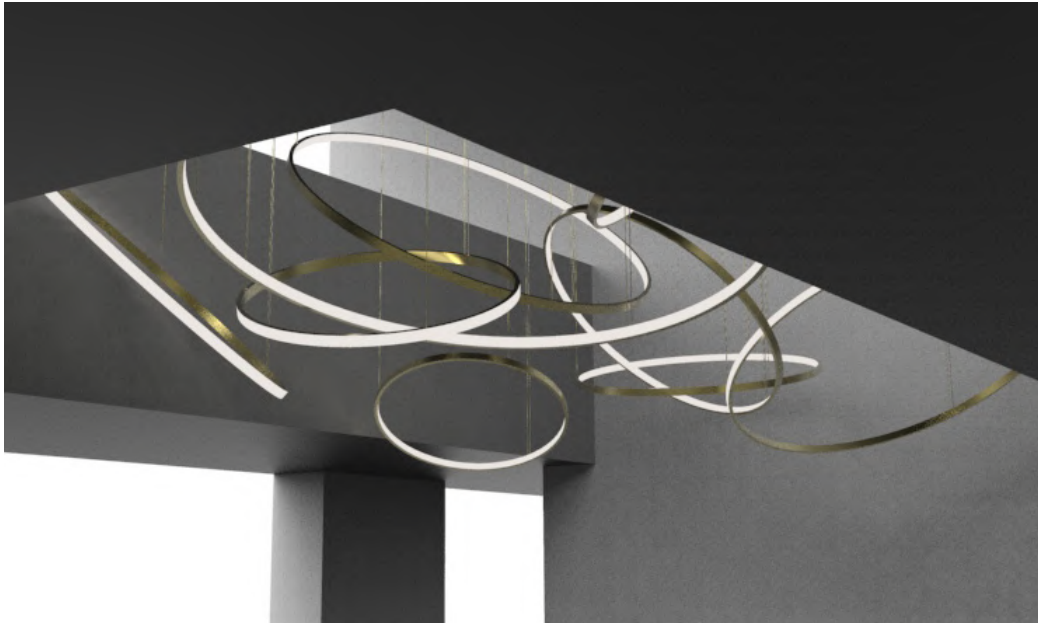

Ø1500mm: 2 IN / 1 OUT - Ø1200mm: 2 IN / 1 OUT - Ø900mm: 2 IN / 1 OUT

AGGIOLIGHT - C19AL-0007

Composition C5

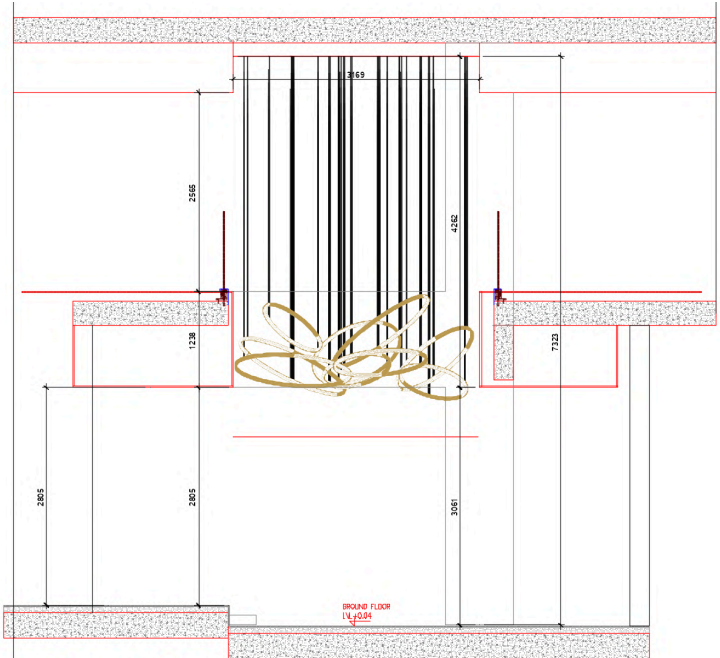

Section @ B

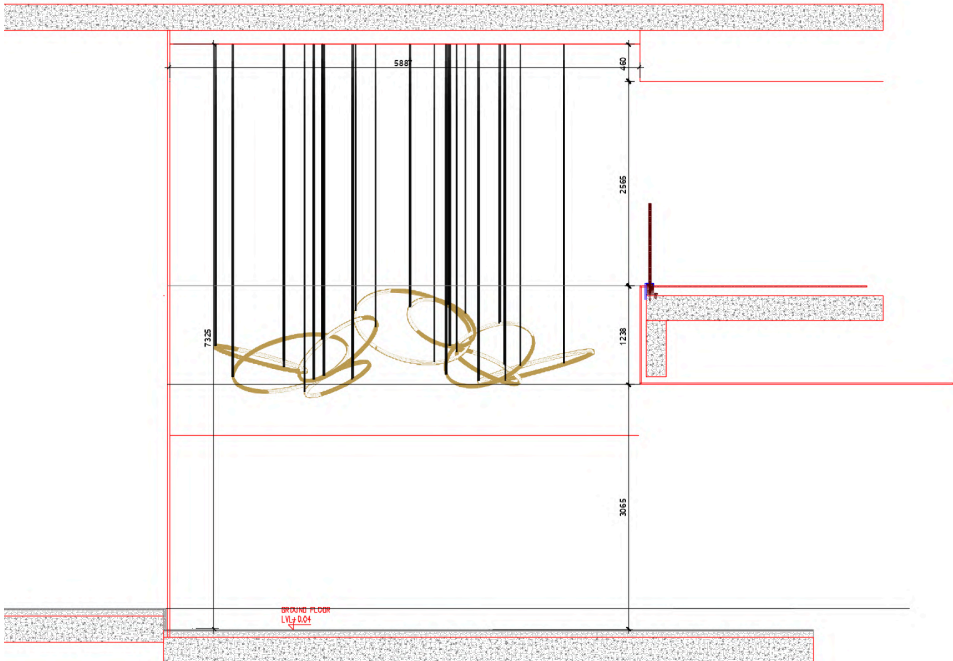

Section @ C

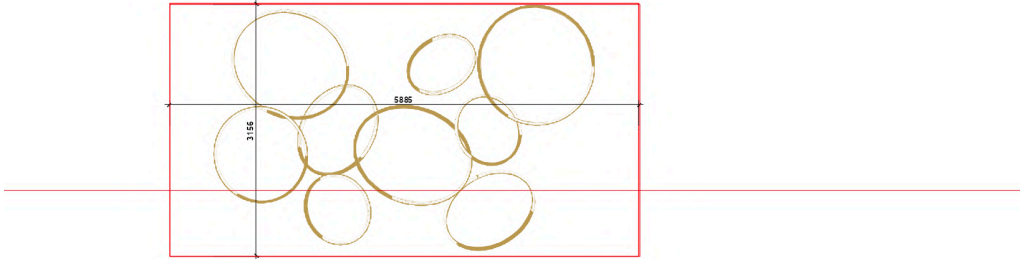
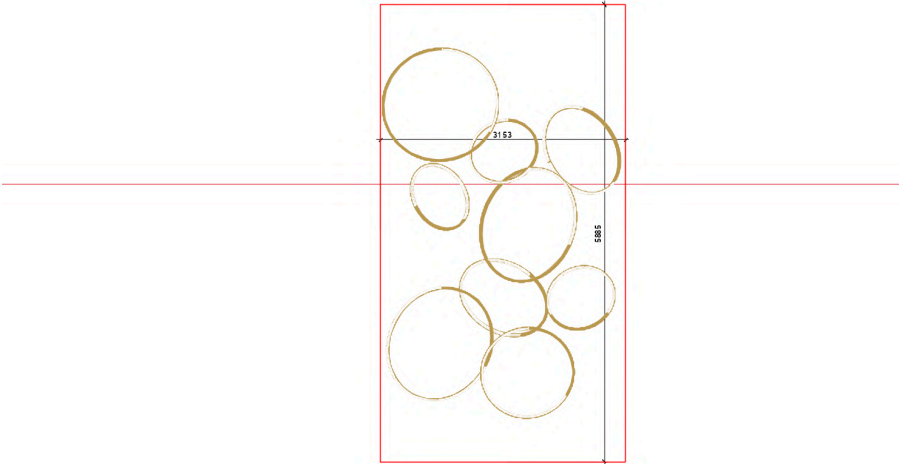

AGGIOLIGHT - C19AL-0007
Composition C6

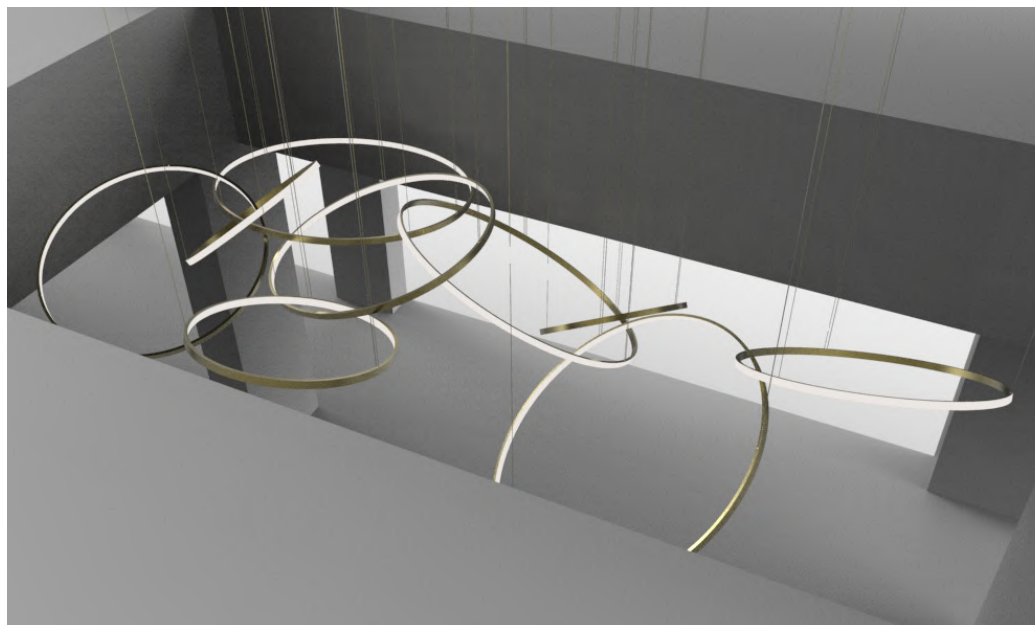
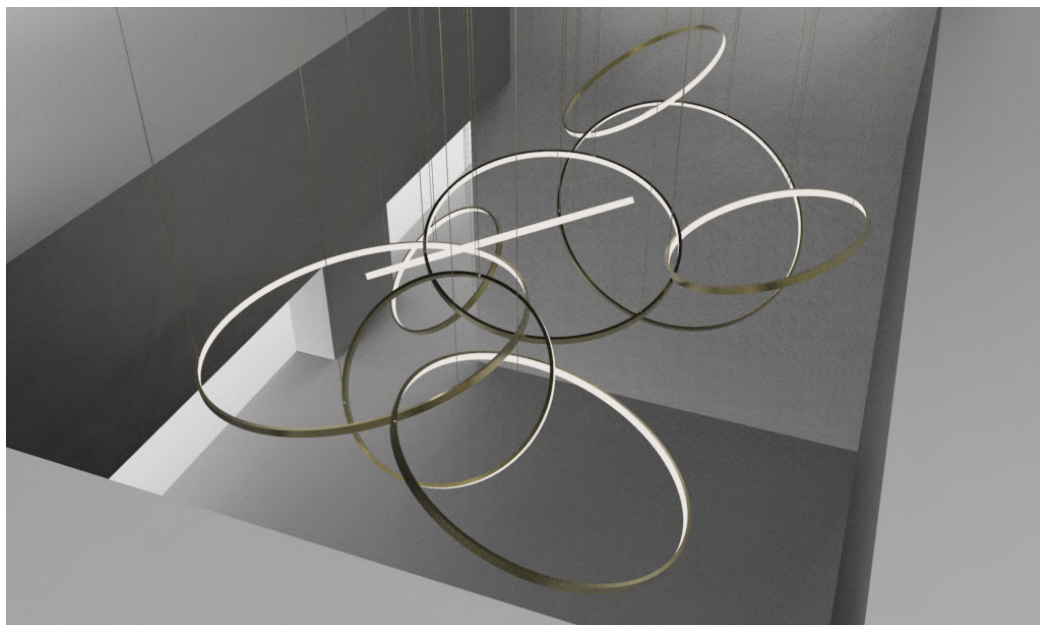
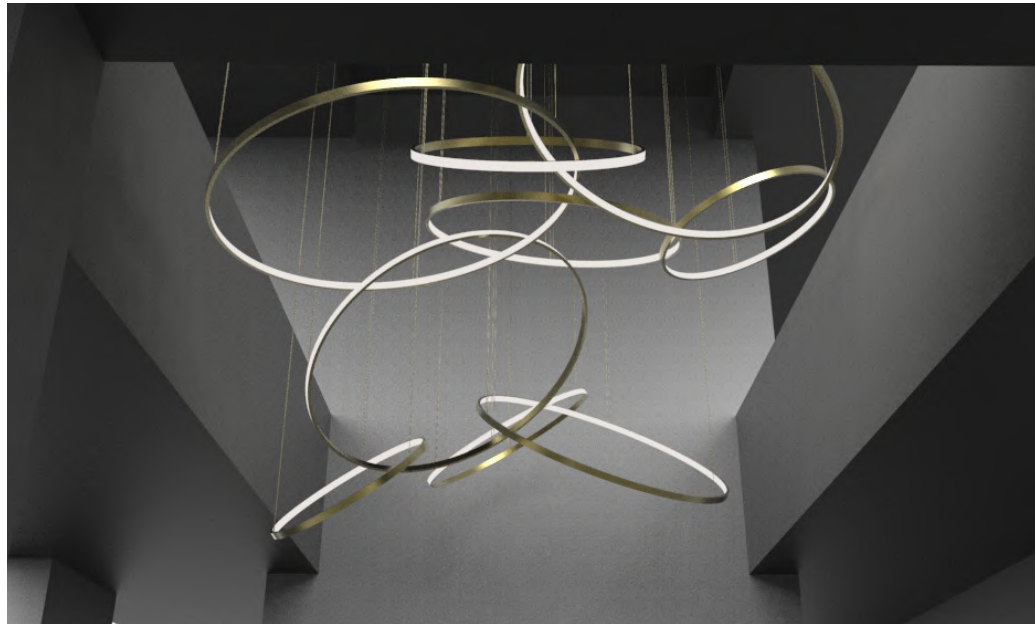
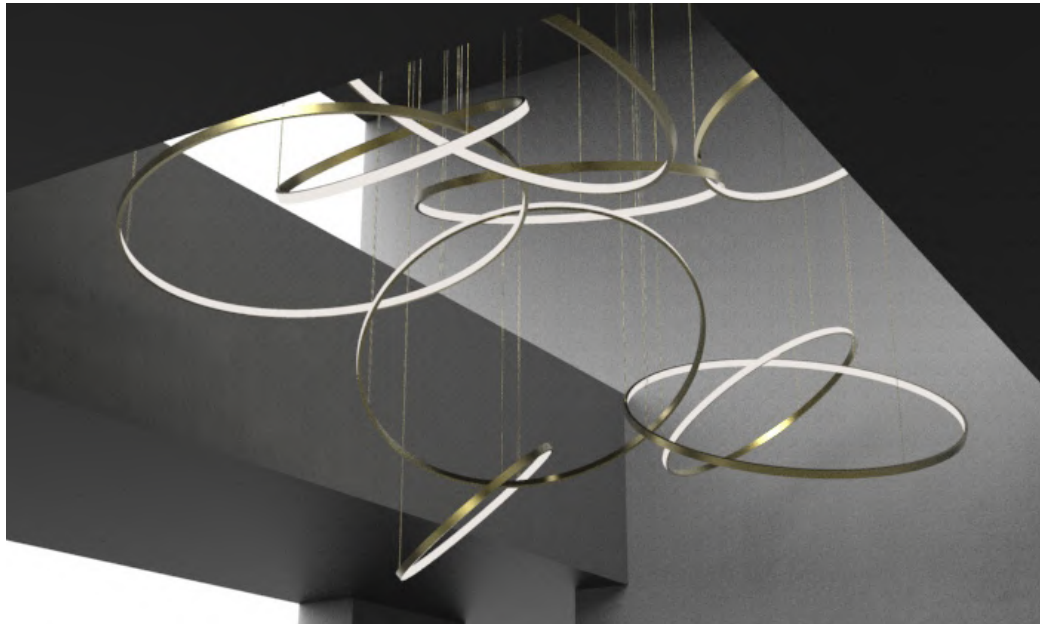

Ø1500mm: 2 IN / 1 OUT - Ø1200mm: 2 IN / 1 OUT - Ø900mm: 2 IN / 1 OUT

AGGIOLIGHT - C19AL-0007

Composition C6

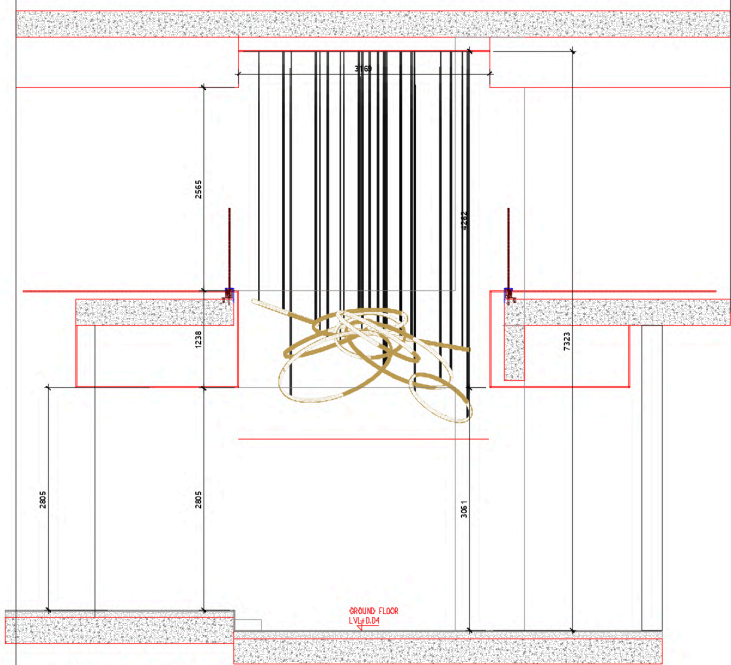

Section @ B

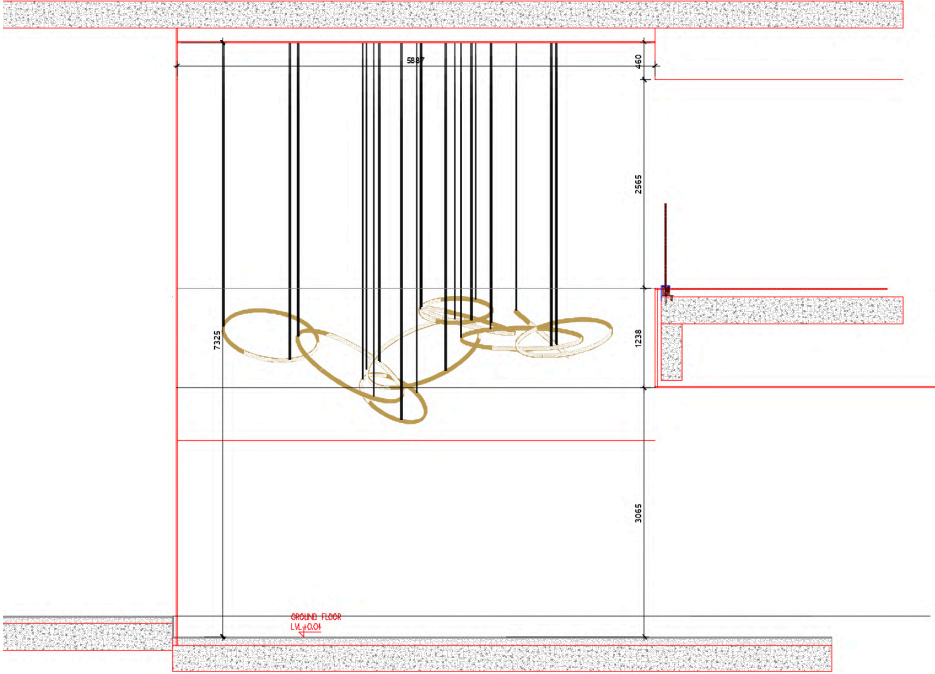

Section @ C

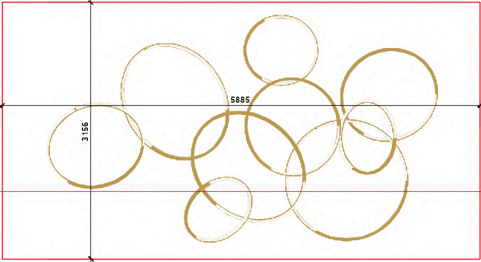
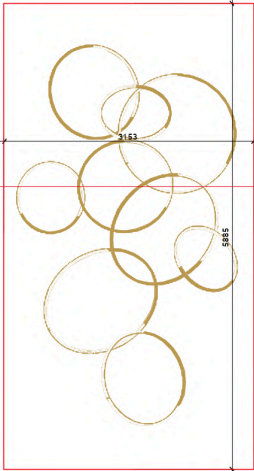

AGGIOLIGHT - C19AL-0007
Composition C7

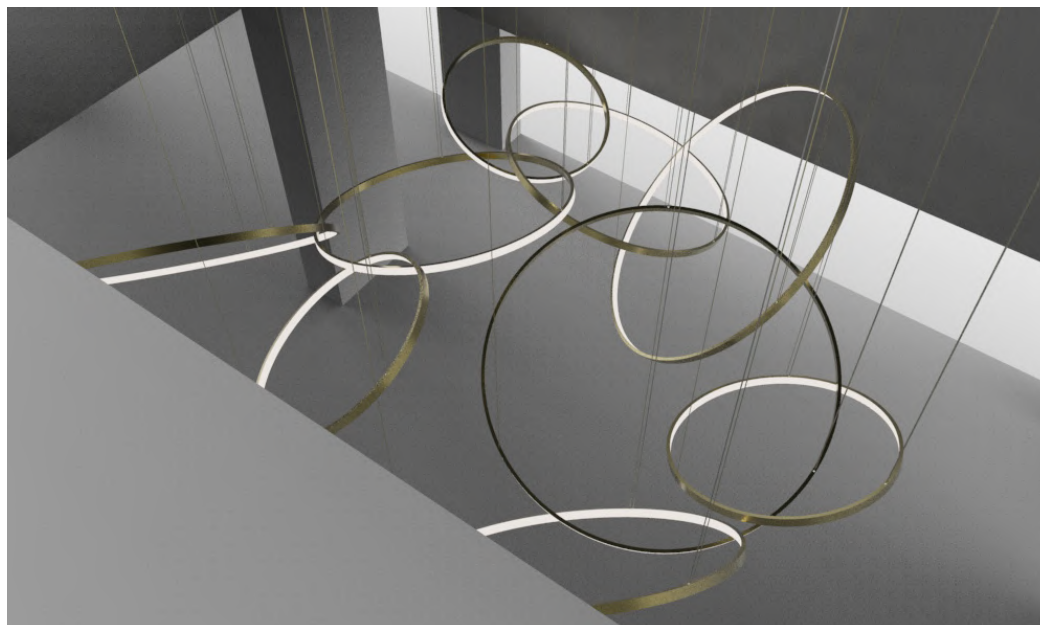
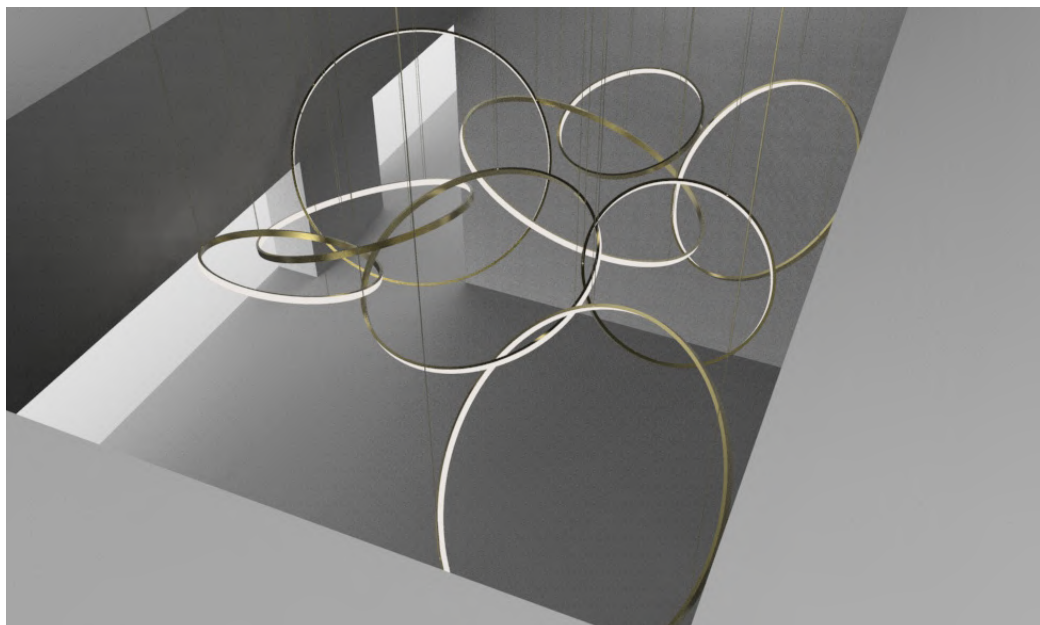
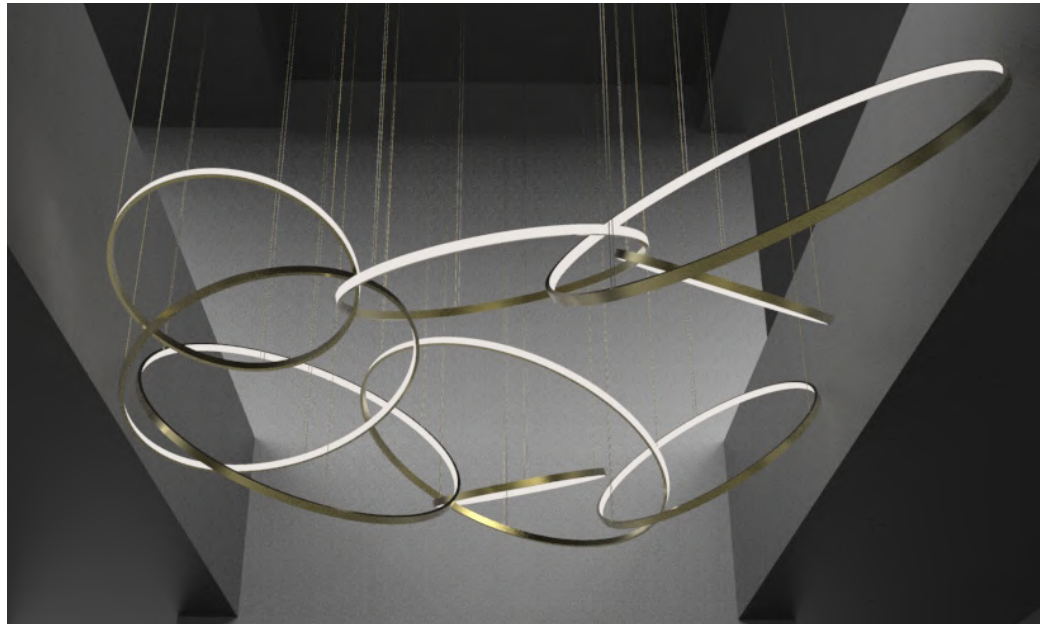
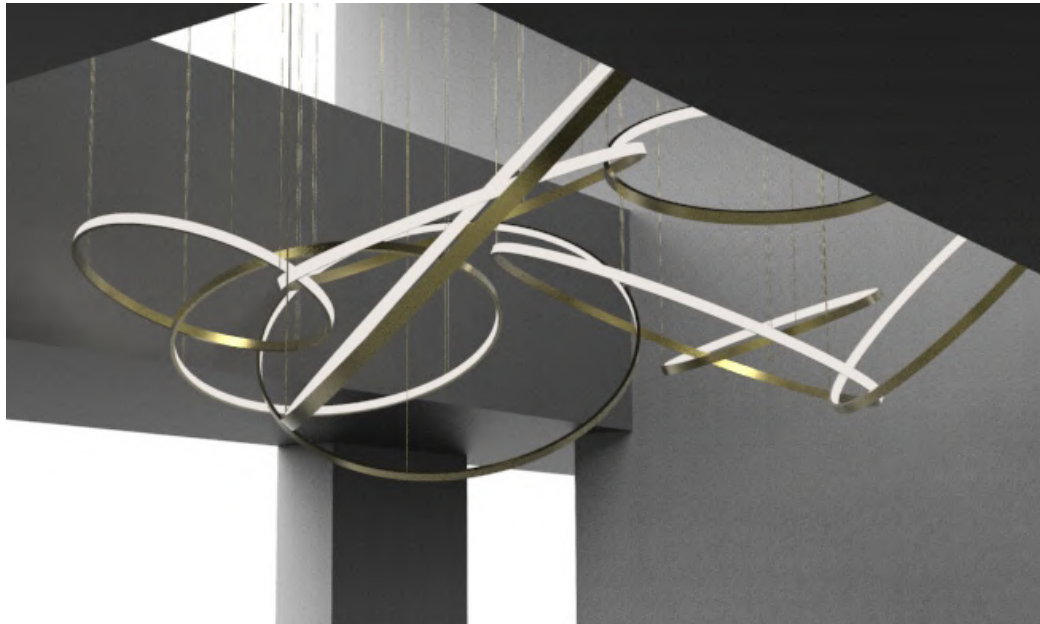

Ø1500mm: 2 IN / 1 OUT - Ø1200mm: 2 IN / 1 OUT - Ø900mm: 2 IN / 1 OUT

AGGIOLIGHT - C19AL-0007

Composition C7

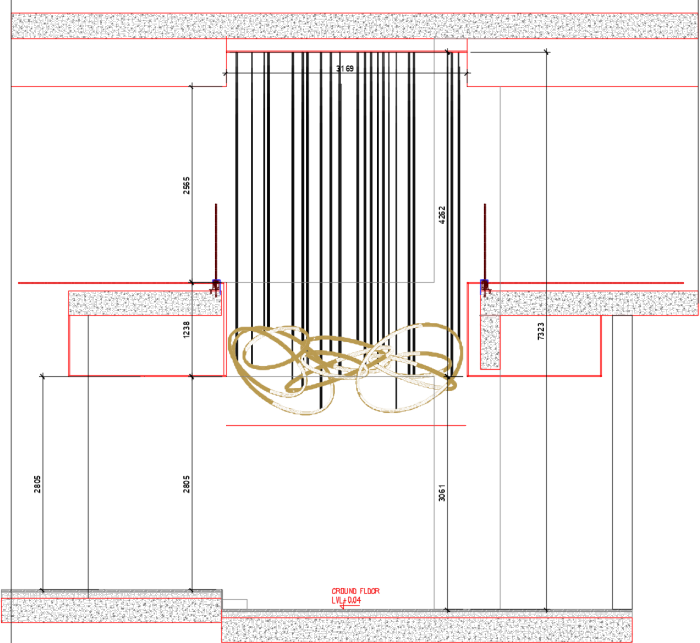

Section @ B

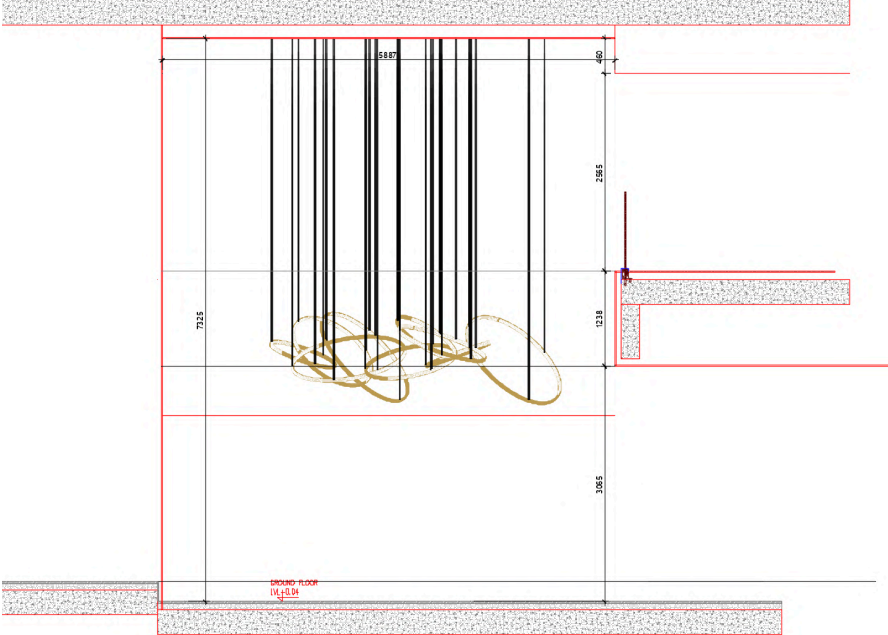

Section @ C

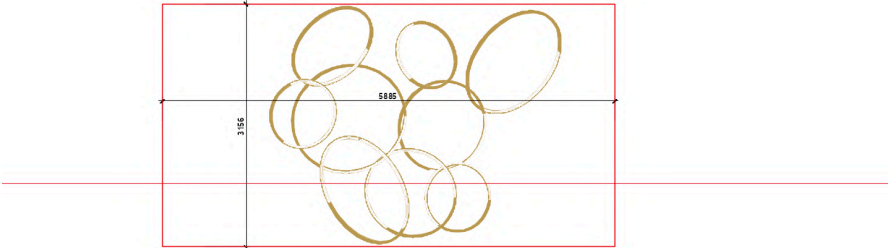
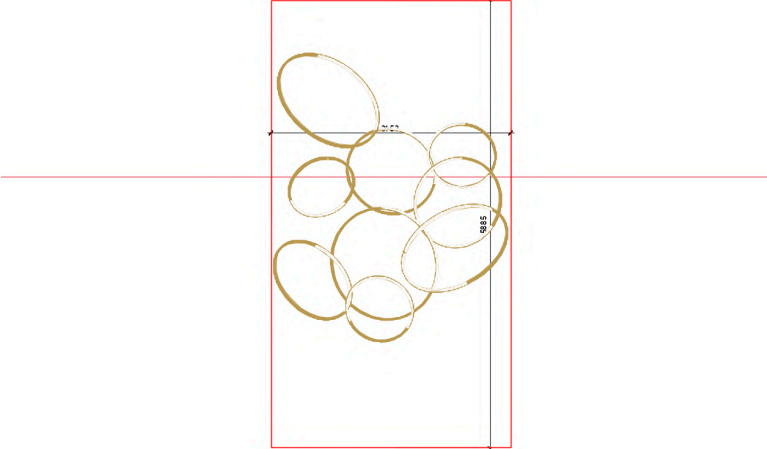

AGGIOLIGHT - C19AL-0007
Composition C8

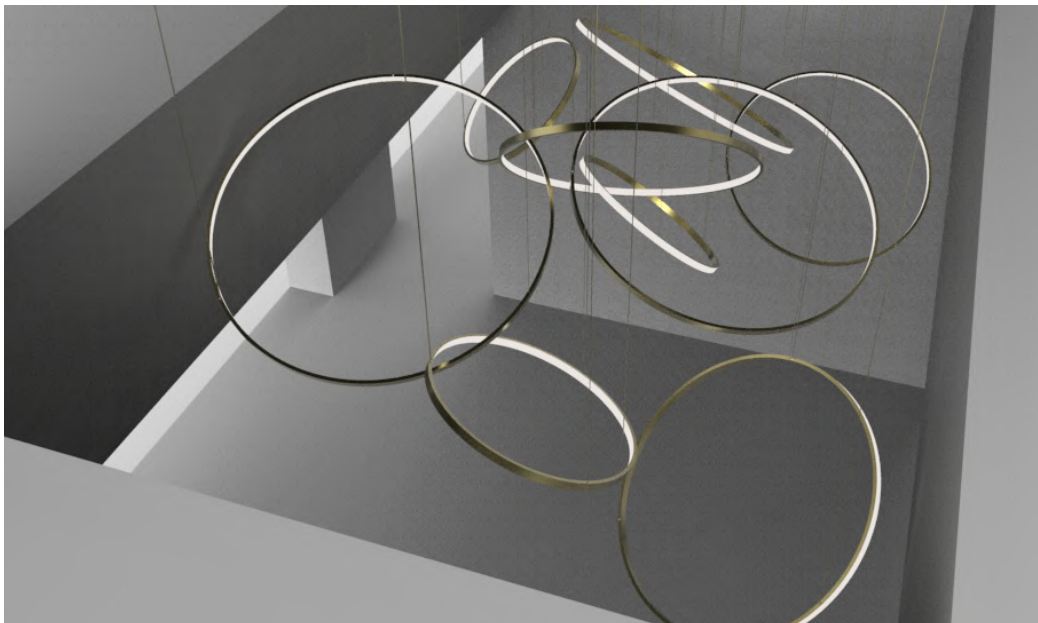
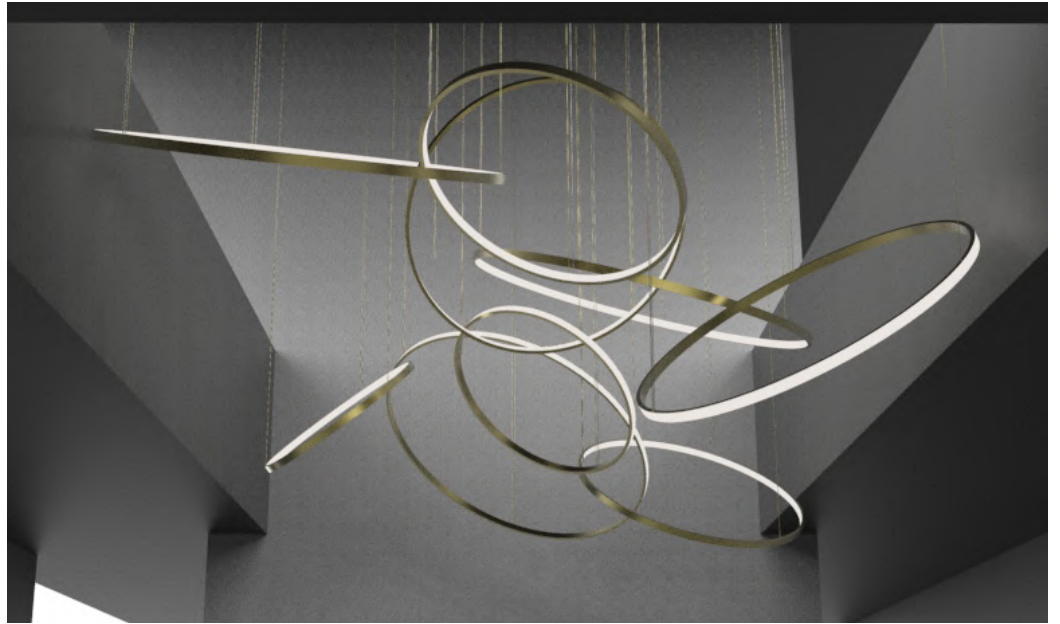
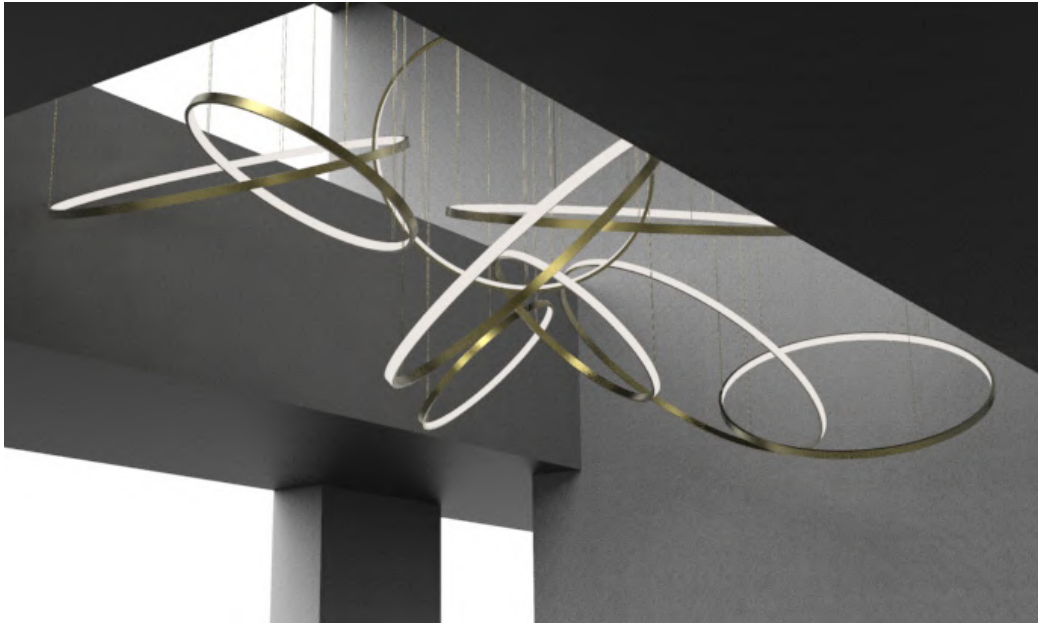

Ø1500mm: 2 IN / 1 OUT - Ø1200mm: 2 IN / 1 OUT - Ø900mm: 2 IN / 1 OUT

AGGIOLIGHT - C19AL-0007
Composition C8

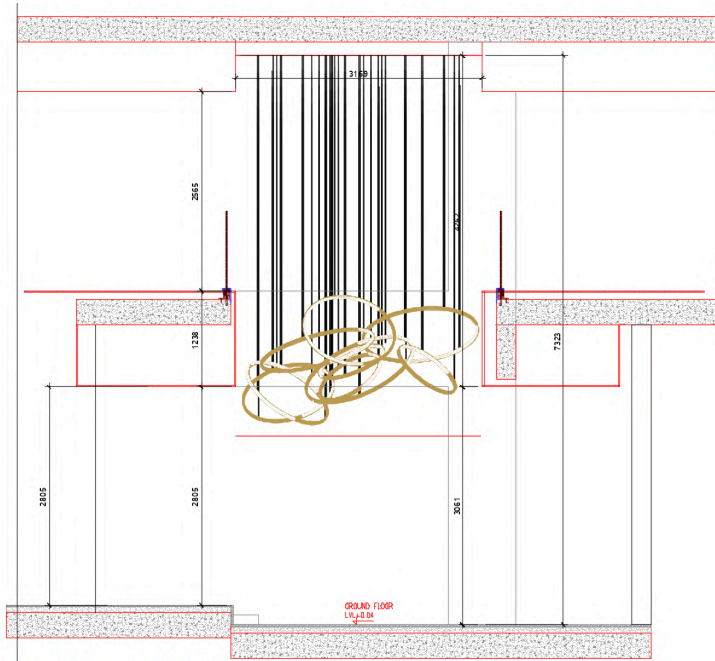

Section @ B

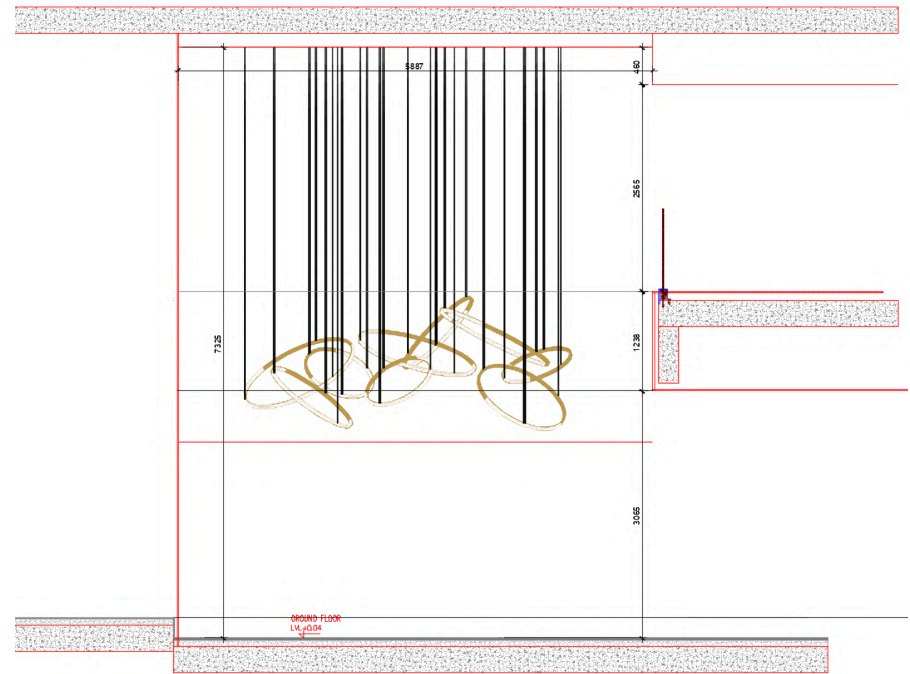

Section @ C

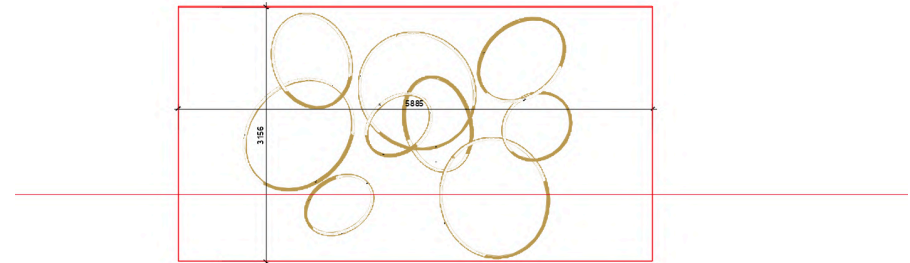
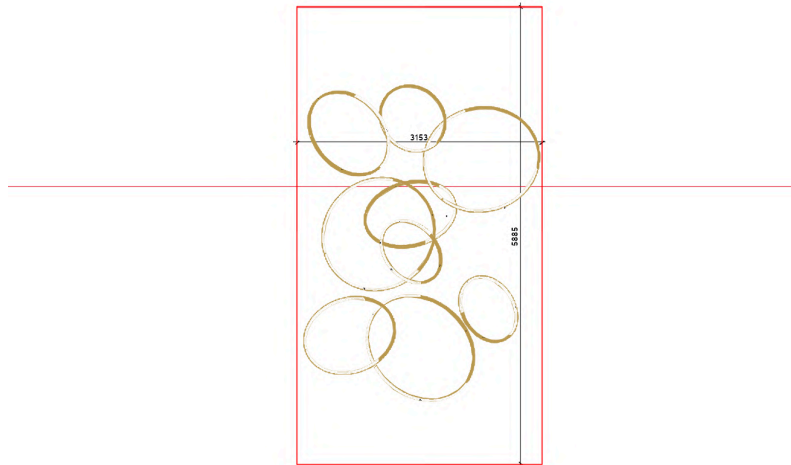

AGGIOLIGHT - C19AL-0007
Composition C9

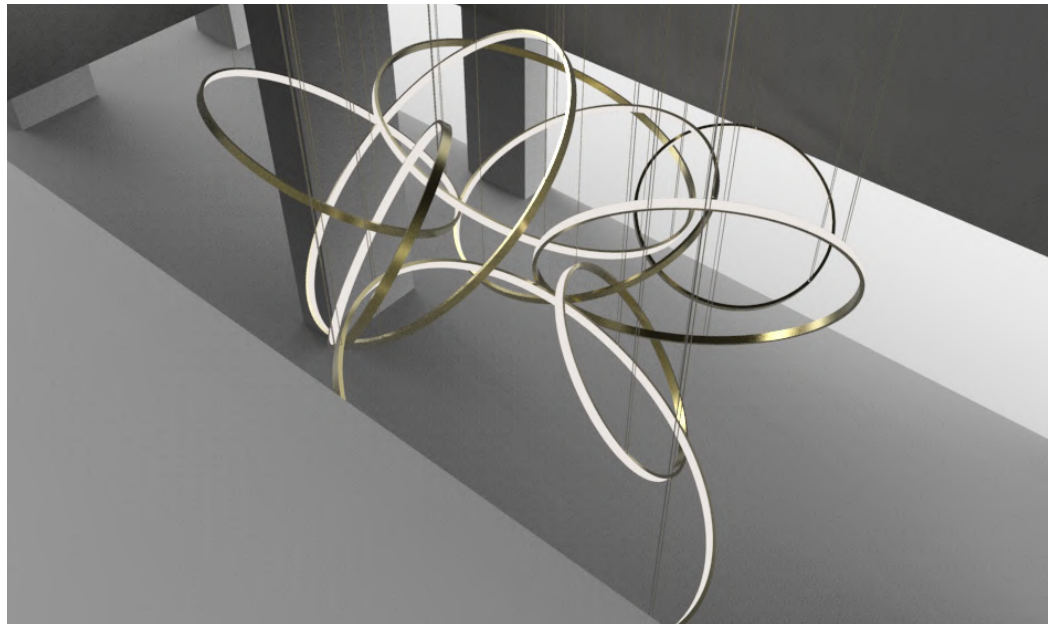
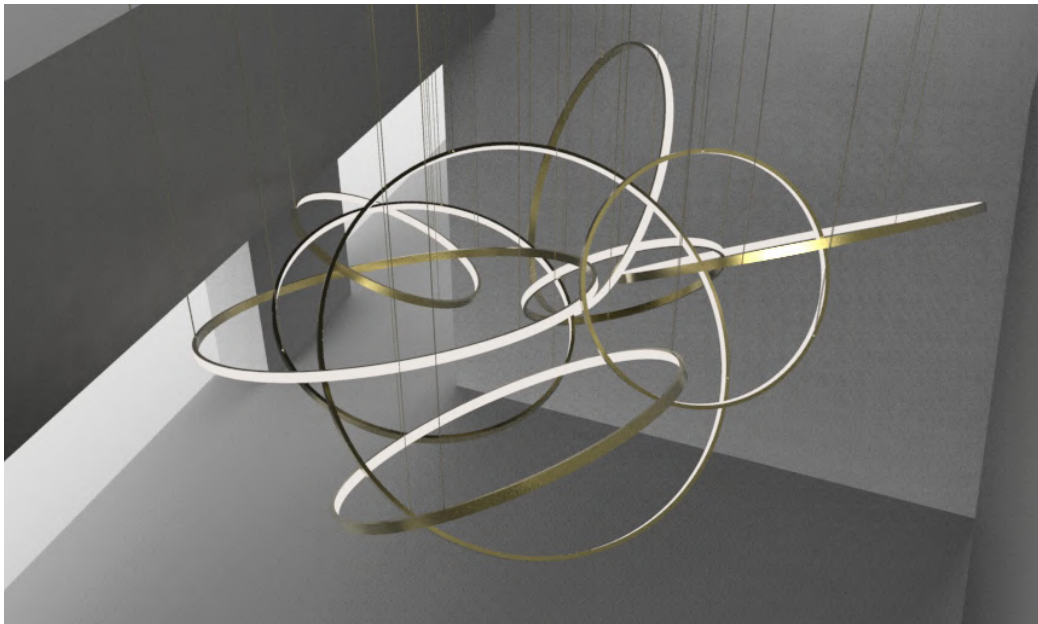
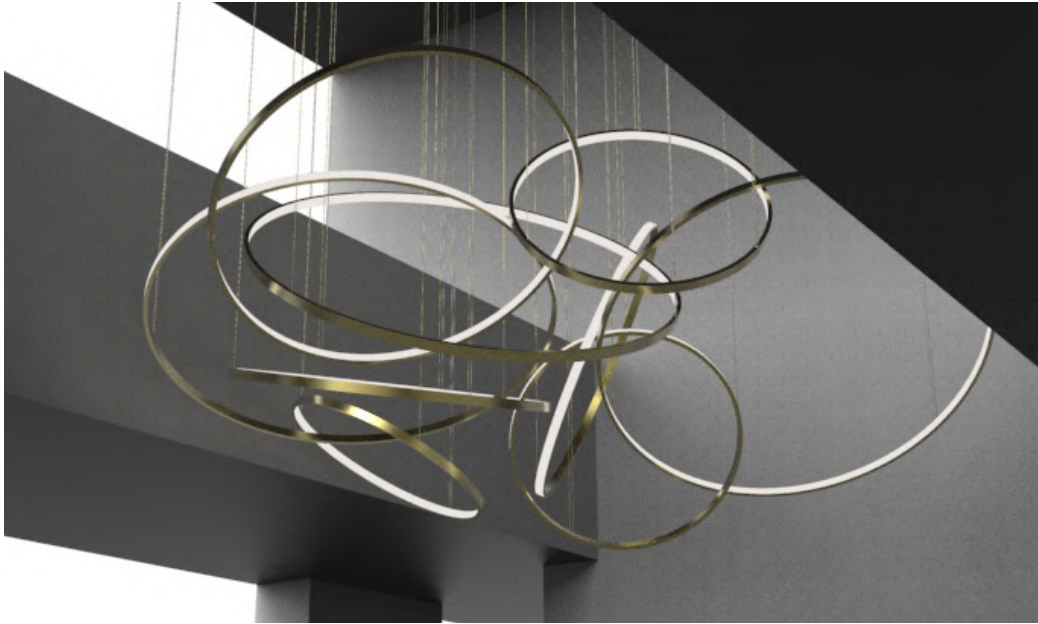

Ø1500mm: 2 IN / 1 OUT - Ø1200mm: 2 IN / 1 OUT - Ø900mm: 2 IN / 1 OUT

AGGIOLIGHT - C19AL-0007
Composition C9

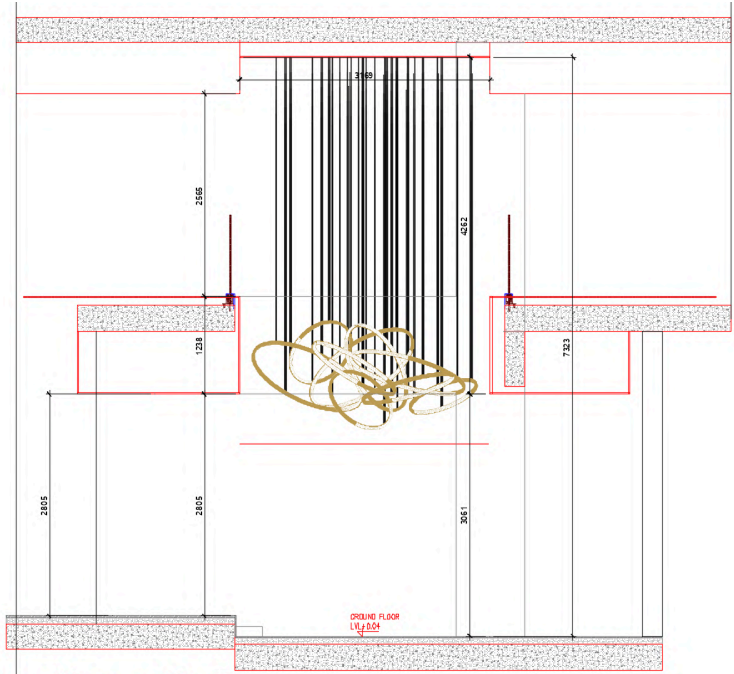

Section @ B

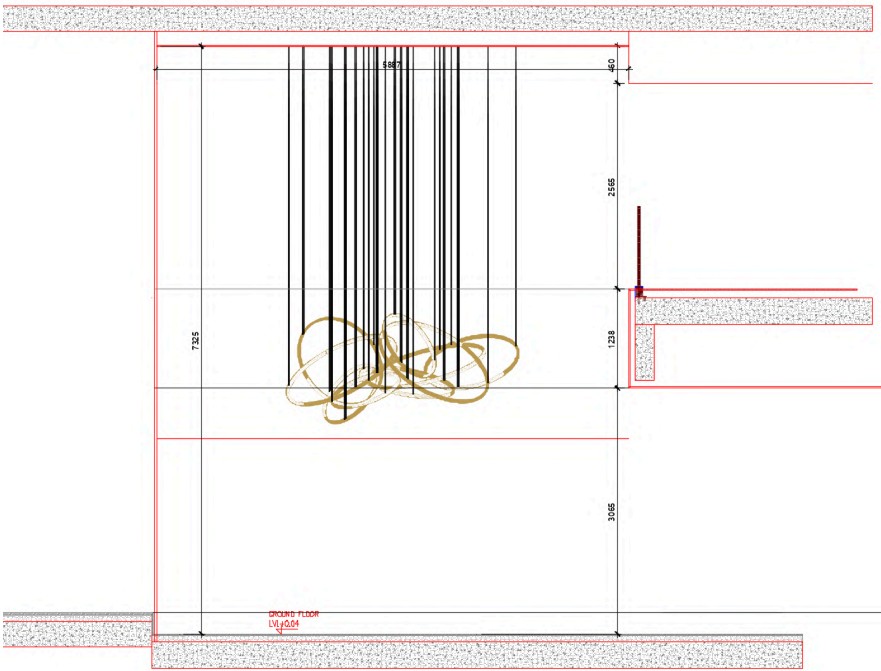

Section @ C

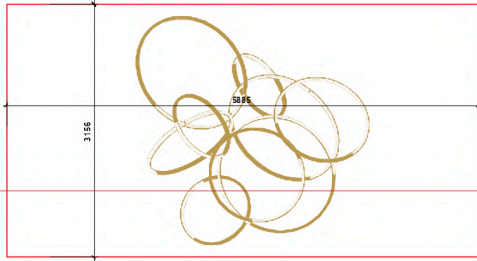

AGGIOLIGHT - C19AL-0007
Composition C10

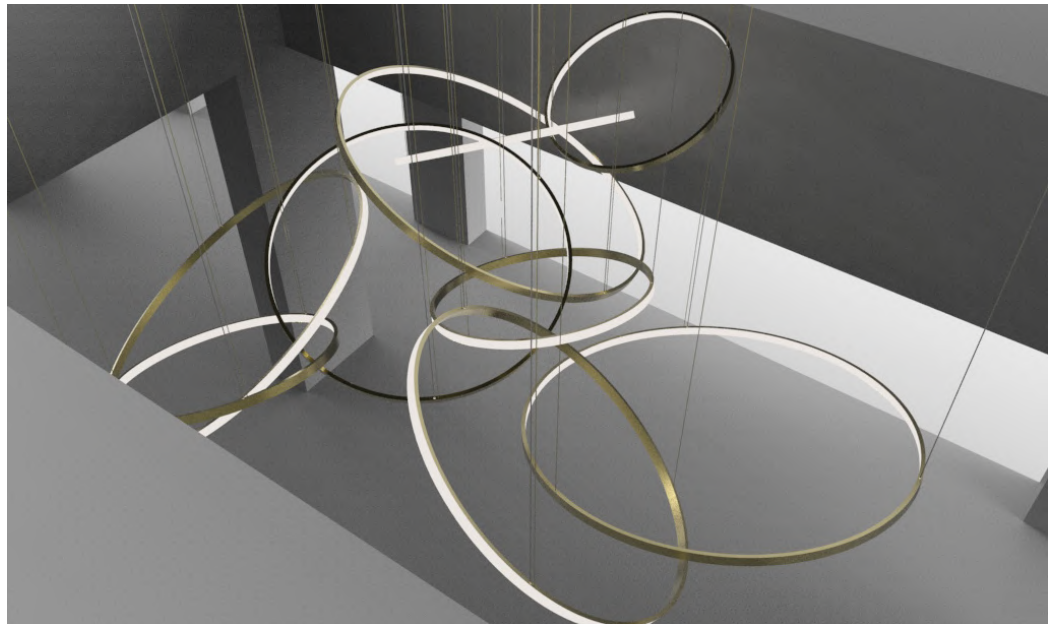
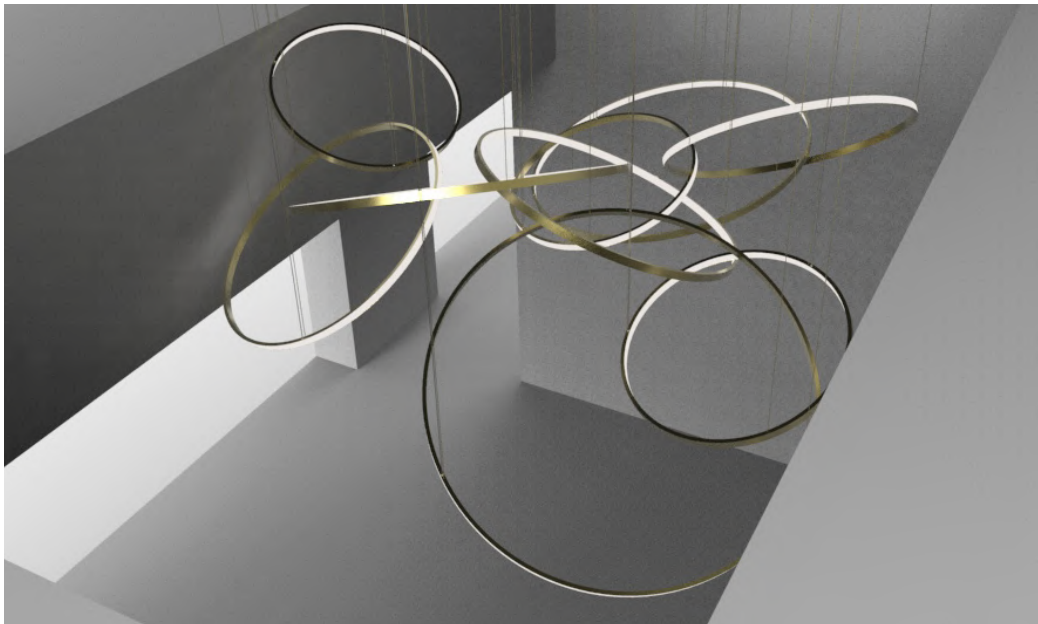

Ø1500mm: 2 IN / 1 OUT - Ø1200mm: 1 IN / 2 OUT - Ø900mm: 2 IN / 1 OUT

AGGIOLIGHT - C19AL-0007
Composition C10

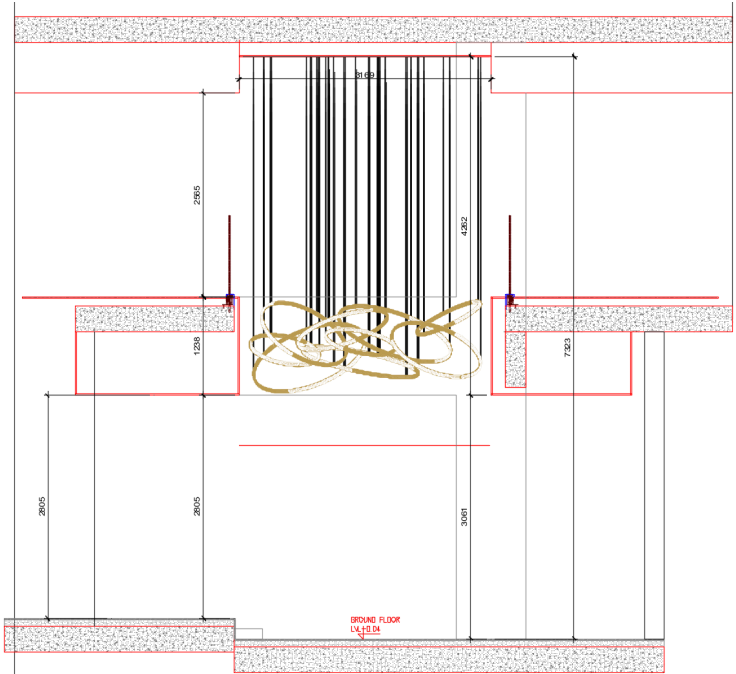

Section @ B

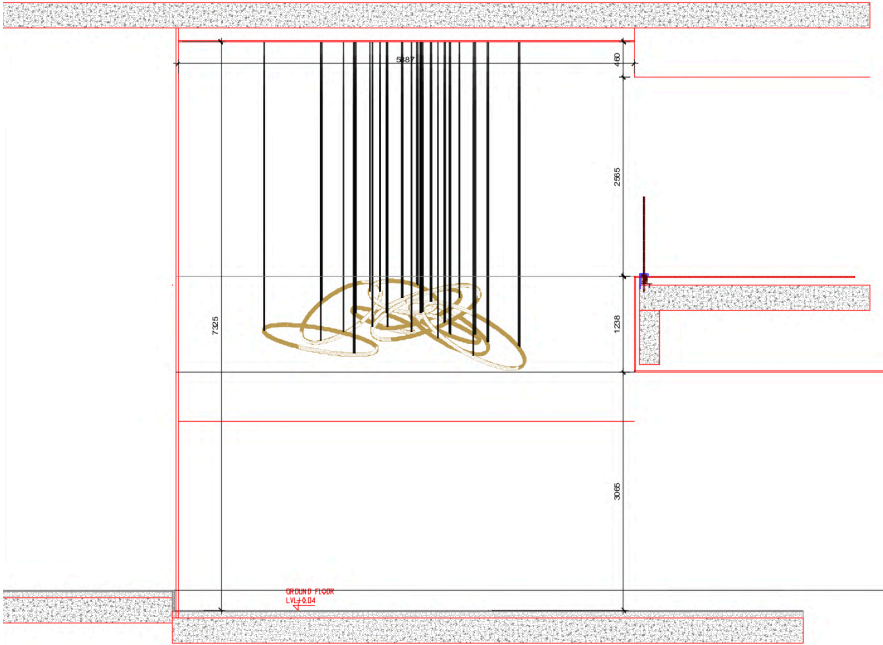

Section @ C

